

# HSF

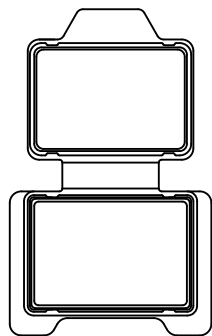

No. 1

将产品装入一个真空盒  
真空盒:SB-01AC(14\*10\*2.4cm)

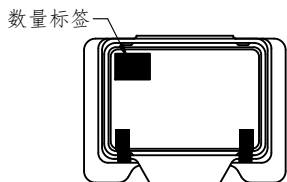

No. 2

用透明胶粘好真空盒,  
并贴真空盒标签

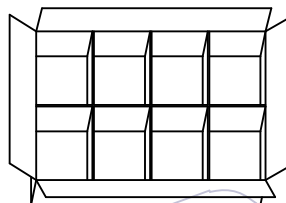

No. 3

在纸箱内套上PE-10防水袋,  
把刀卡拼好放入纸箱, 如上图  
纸箱:CTN-05K (45.5\*29.5\*17.0cm)  
刀卡:CTN-GB01 (45.0\*15.5\*0.3cm)  
CTN-GB02 (29.0\*15.5\*0.3cm)

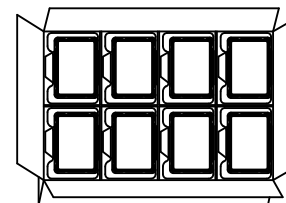

No. 4

将真空盒装入纸箱 (48盒/箱)  
放入两包干燥剂, 再将防水袋封口

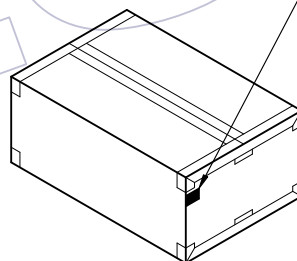
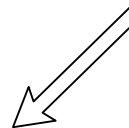

No. 5

封箱, 贴纸箱标签

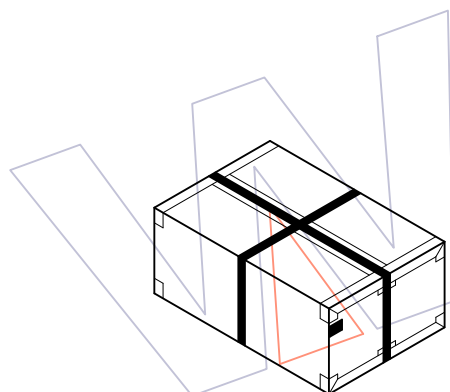

No. 6

打十字型包装带

## 说明:

1. 产品如图所示型态放入真空盒
2. 注意各标签样式、位置及方向的一致性;
3. 标签如客户有特殊要求, 则按客户要求黏贴;
4. 打外箱包装带时需注意, 打为十字型, 另出国内客户, 未打包装带。
5. 如订单数量不足24盒, 则使用CTN-21外箱出货
6. 未尽事宜依交货注意事项包装

变更  
记事

|           |            |                                  |              |               |                    |             |               |            |       |     |                                                                                                                             |
|-----------|------------|----------------------------------|--------------|---------------|--------------------|-------------|---------------|------------|-------|-----|-----------------------------------------------------------------------------------------------------------------------------|
|           |            |                                  |              |               | 工程图<br>ENGINEERING | 绘图<br>DRAW  | 苏 珊           | 2023/03/14 | SCALE | Fit | <br>WCON ELECTRONICS (GUANGDONG) CO.,LTD<br>料号 PART NO. 13XX-X2XXXXRXXXCAXX<br>品名 TITLE: 1.27mm Pin Header, 2*XXP, R/A 盒装规范 |
|           |            |                                  |              |               | X.X                | ±0.30       | 设计<br>DESIGN  |            | UNIT  | mm  |                                                                                                                             |
|           |            |                                  |              |               | X.XX               | ±0.20       | 审核<br>CHECK   |            | SIZE  | A4  |                                                                                                                             |
| A0        | 2023/03/14 | NEW                              |              |               | X.XXX              | ±0.10       | 核准<br>APPROVE |            | SHEET | 1/1 |                                                                                                                             |
| 版次<br>REV | 日期<br>DATE | 变更说明<br>MODIFICATION DESCRIPTION | 变更<br>CHANGE | 核准<br>APPROVE | Angle<br>DIM       | ± 2'<br>TOL | 核准<br>APPROVE |            | PROJ. | ☉   |                                                                                                                             |