

NOTES:  
 No. of Positions: 8 Pin  
 Housing Material: PBT  
 Wire Size Range: 20-16AWG(1.0-1.5mm<sup>2</sup>)  
 Operation Temperature: -40°C to +125°C  
 Waterproof grade: IP68/IP69K(After installation)

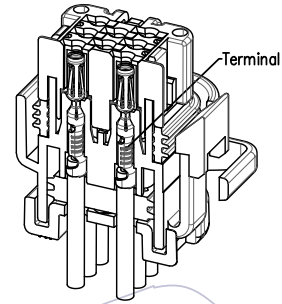

Serial Number	Part Name	Material	Consumption
1	Line end shell	PBT / BLACK	1
2	Line end sealing ring	Silicon rubber	1
3	Main body	PBT / BLACK	1
4	Main sealing ring	Silicon rubber	1
5	Lock cover	PBT / RED	1

Assembly sketch

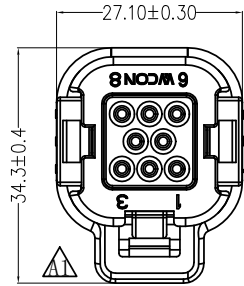
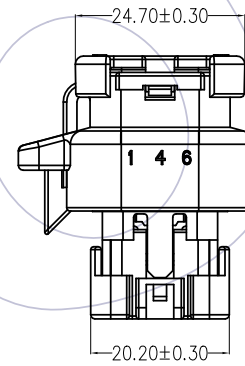
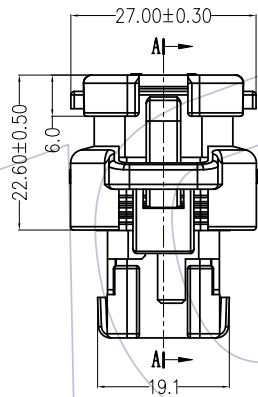
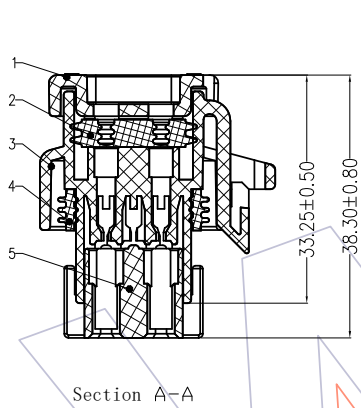

Stay Basin

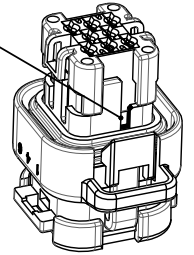
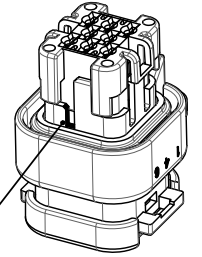

### Ordering Information

74040-3FC 008 A N 00 W A 1 W

No. of Pins:  
008=8P

Body Material:  
A=PBT

A=Tray W=I/T WCON LOGO  
Blank=W/O LOGO

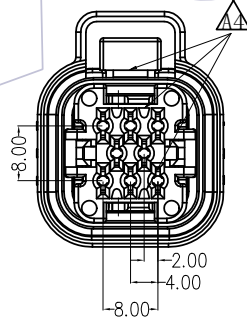

Matched Plug Number:

- 74040-3MS008ABXXNA1 (W)
- 74040-3MS008ABXXJA1 (W)
- 74040-3MR008ABXXNA1 (W)
- 74040-3MR008ABXXJA1 (W)

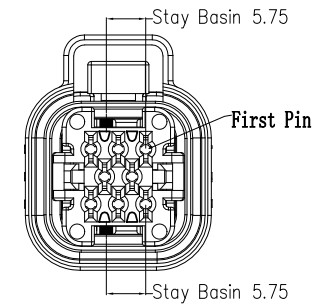

REV	DATE	MODIFICATION DESCRIPTION	CHANGE	DIM	TOL	OPERATION	DRAW XSR	DATE	SCALE	FIT	PART NO.
A4	2021/08/18	Modify	---			OPERATION		2021/08/18	UNIT	mm	74040-3FC008AN00WA1 (W)
A3	2019/12/03	Modify	---	X.X	±0.40	CHECK		DATE	inch		
A2	2019/03/18	Modify	---	X.XX	±0.25				SIZE	A4	TITLE: 4.0X4.0 three row car connector line end 8P socket
A0	2018/09/01	NEW	---	X.XXX	±0.15				SHEET	1/1	Customer NO.
				Angle	± 3'	APPROVE		DATE	PROJ.		

**WCON**  
 Http: www.wcon.com

WCON-Dongguan Tel: +86 769 85358920  
 WCON-Kunshan Tel: +86 512 57468408  
 Fax: +86 769 85358915  
 Fax: +86 512 57468468  
 E-mail: sales@wcon.com  
 E-mail: sales@wcon.com