

# HSF

NOTES:  
 Rated Current: 1.0A  
 Rated Voltage: 100V AC/DC  
 Contact Resistance: 20mΩ max  
 Withstand Voltage: 500V AC/Minute  
 Insulation Resistance: 500MΩ min  
 Operation Temperature: -25°C to +85°C  
 Material: PA66 UL94V-0

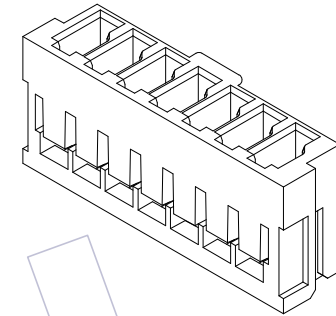

3D VIEW  
REFERENCE

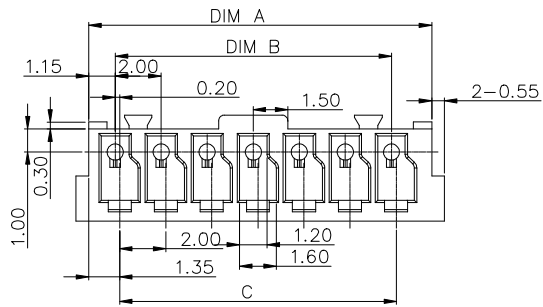
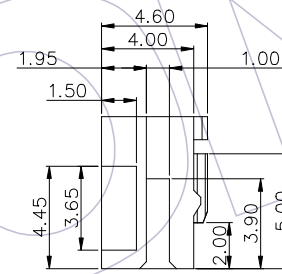
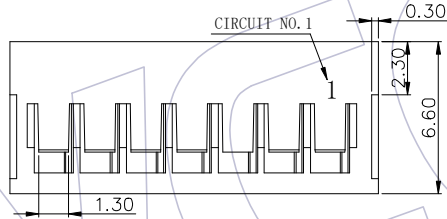

## Ordering Information

WF2006 - H XX X 0 1

No. of pins    Color    Packing  
 02P~16P    W=White    0=PE Bag

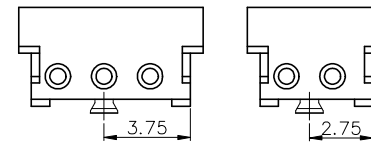
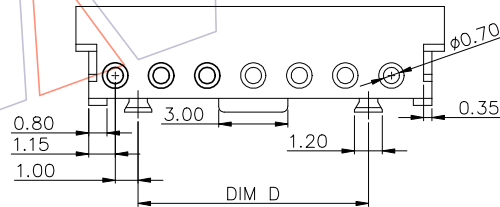

3PIN示意图

2PIN示意图

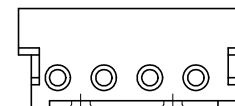

4PIN示意图

15	30.90	28.00	28.00	26.00
14	28.90	26.00	26.00	24.00
13	26.90	24.00	24.00	22.00
12	24.90	22.00	22.00	20.00
11	22.90	20.00	20.00	18.00
10	20.90	18.00	18.00	16.00
9	18.90	16.00	16.00	14.00
8	16.90	14.00	14.00	12.00
7	14.90	12.00	12.00	10.00
6	12.90	10.00	10.00	8.00
5	10.90	8.00	8.00	6.00
4	8.90	6.00	6.00	4.00
3	6.90	4.00	4.00	NA
2	4.90	2.00	2.00	NA
POS	DIM A	DIM B	DIM C	DIM D

REV	DATE	MODIFICATION DESCRIPTION	CHANGE	OPERATION	DRAW	DATE	SCALE	FIT	PART NO.
A1	2019/09/12	Modify Drawing	-----	x.x ±0.40	Liu	2019/09/12	UNIT	mm	WF2006-HXXX01
A0	2008/08/04	NEW	-----	x.xx ±0.25	CHECK	DATE	SIZE	A4	TITLE:
				x.xxx ±0.15	APPROVE	DATE	SHEET	1/1	2.00 HOUSING
				Angle ± 3°			PROJ.	Customer NO.	
				DIM TOL					

**WCON**  
 Http: www.wcon.com

WCON-Dongguan    WCON-Kunshan  
 Tel: +86 769 85358920    Tel: +86 512 57468408  
 Fax: +86 769 85358915    Fax: +86 512 57468468  
 E-mail: sales@wcon.com    E-mail: sales@wcon.com