

No: 1

产品装入真空管内
SG-B122 (600*13.2*16.0mm)

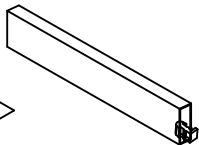

No: 2

塞塑胶塞

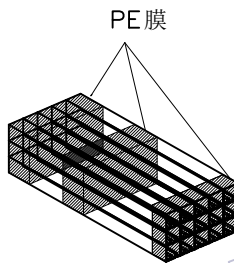

No: 3

30管为一扎
用PE膜固定每扎真空管两端及中间,
包住两端利角,以防划破胶袋

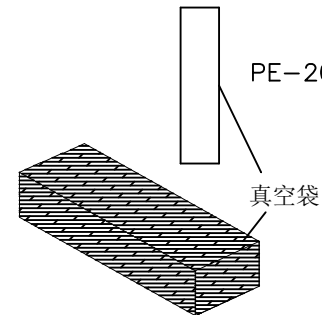

No: 4

将3扎包扎好的真空管装入真空袋,
外加2包干燥剂,机台抽真空
PE-20A规格: 35*95cm

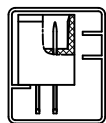

产品摆放示意图

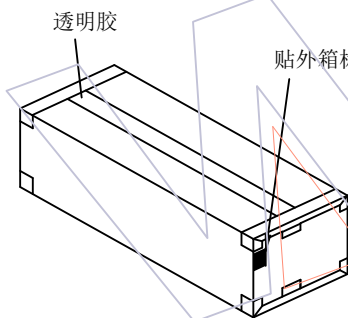

No: 7

封箱及贴标签于外箱侧面的左上角

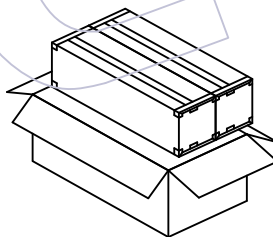

No: 6

内箱放入外箱(2内箱/外箱)
外箱规格:CTN-10C(双坑 65*33*19CM)

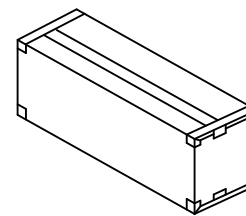

No: 5

将抽真空的产品,放入内箱
(3扎/内箱)封箱
内箱规格:CTN-10A(63*15*17CM)

2.54mm DFCN 公座180度DIP 内带M2.6螺母

PIN	产品长度	真空管装数量	每内箱装数量	每外箱装数量
8	28.84	20	1800	3600
16	39.00	14	1260	2520
24	49.16	11	990	1980
32	59.32	9	810	1620
40	69.48	8	720	1440
48	79.64	7	630	1260
56	89.80	6	540	1080
64	99.96	5	450	900

说明:

1. 产品如图所示形态放入真空管
2. 注意各标签样式,位置及方向的一致性
3. 当订单数量不足一内箱数量时,内箱可充当外箱使用,并贴标签

变更记事

版次 REV	日期 DATE	变更说明 MODIFICATION DESCRIPTION	变更 CHANGE	核准 APPROVE	零件图	颜色 COLOR	材质 MATERIAL	设计 DESING	审核 CHECK	核准 APPROVE	SCALE	FIT
A0	2023/03/21	NEW			X.			巫美洁	2023/03/21		UNIT	mm
					X.X	±0.20					SIZE	A4
					X.XX	±0.10					SHEET	1/1
					X.XXX	±0.05					PROJ.	
					Angle							
					X.	± 2'						
					DIM	TOL						

WCON

WCON ELECTRONICS (GUANGDONG) CO. LTD

料号 PART NO. 6340-1XXMSSXMNT01

品名 TITLE: 2.54mm DFCN Conn. S/T Male XXP W/T M2.6 Nut, W/O Lock H=10.3, DIP=4.2 管装规范