

HSF

NOTES:

Rated Current:

4.0AMP

Contact Resistance:

Initial: 15mΩ Max.Final: 25mΩ Max.

Insulation Resistance:

100MΩ Min.

Operation Temperature:

-40℃ to +105℃

Insulator Body Material: PBT BLACK/GRAY

Cover Material: PBT BLACK/GRAY

Attention:

1.This product does not contain terminals and wires.

2.The product consists of housing and cover

40P	47.1±0.40	41.8±0.30
36P	42.7±0.40	37.4±0.30
32P	38.3±0.40	33.0±0.30
28P	33.9±0.40	28.6±0.30
24P	29.5±0.40	24.2±0.30
20P	25.1±0.30	19.8±0.30
16P	20.7±0.30	15.4±0.20
12P	16.3±0.30	11.0±0.20
PIN数	A	B

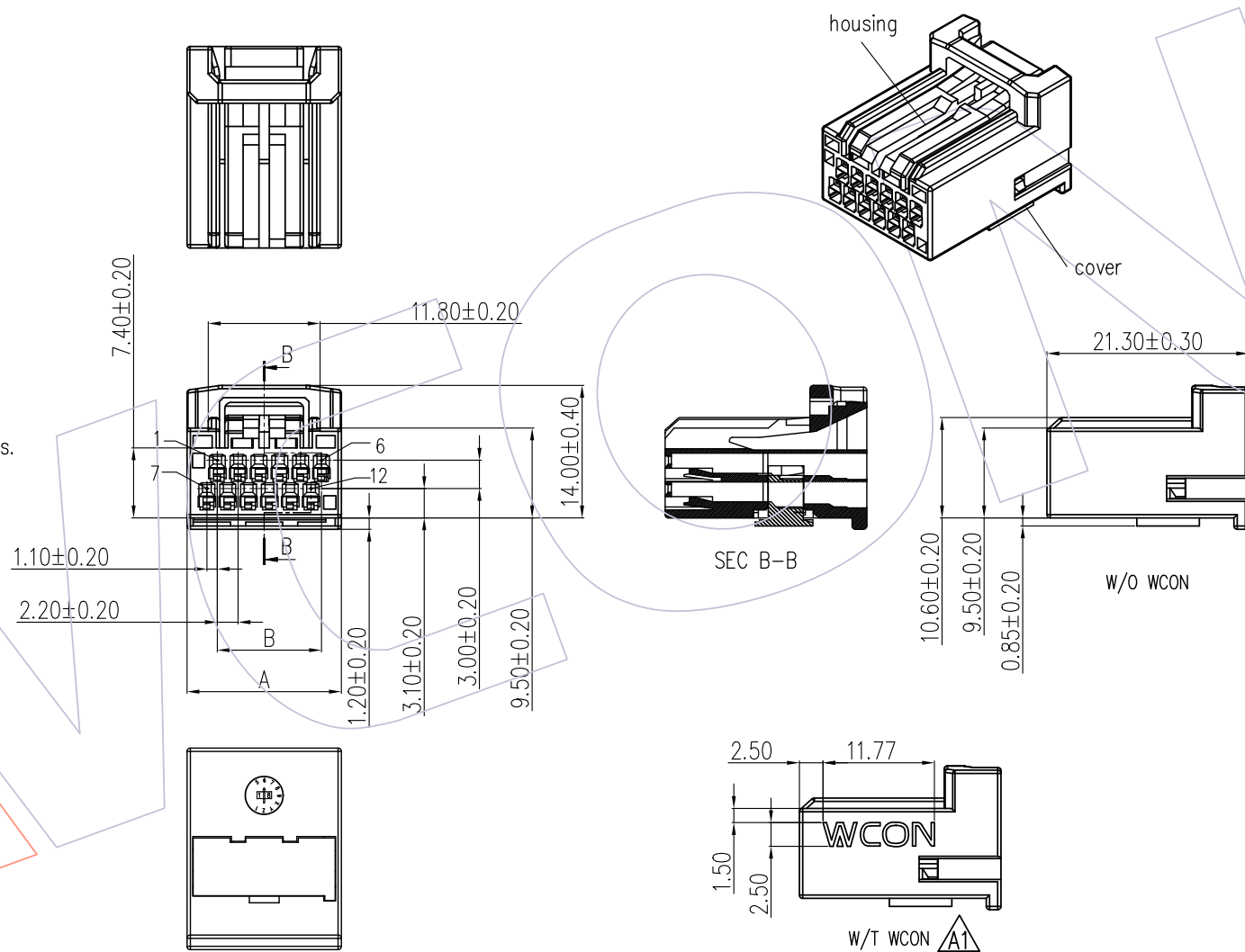

REV	DATE	MODIFICATION DESCRIPTION	CHANGE	OPERATION	DRAW	DATE	SCALE	Fit	PART NO.
A2	2021/09/03	Modify Operation Temperature&Update drawing	Morris	x. ±0.60	Morris	2021/09/03	UNIT	mm [inch]	72230-2FCXXXAX00BA1(W)
A1	2021/03/17	Add W/T WCON SPEC.&P/N	XSR	x.x ±0.40	CHECK	DATE	SIZE	A4	TITLE: 2.2 * 3.0mm Auto-Conn, Dual Row, Female ,Crimp TYPE ,W/C
A0	2021/02/26	NEW	Morris	x.xx ±0.25	APPROVE	DATE	SHEET	1/4	Customer NO.
				Angle ± 3°			PROJ.		
				DIM TOL					

WCON
 Http: www.wcon.com
 WCON-Dongguan Tel: +86 769 85358920
 WCON-Kunshan Tel: +86 512 57468408
 Fax: +86 769 85358915 Fax: +86 512 57468468
 E-mail: sales@wcon.com E-mail: salesks@wcon.com

HSF

Ordering Information

72230-2FCXXXAX00BA1W

Female
Crimp Type
No. of Pins
012=12 Pin
036=36 Pin
040=40 Pin

Plastic Material:
A=PBT

W=W/T WCON
Blank=W/O WCON
Wcon Internal Code
Package
A=Tray
Non-watertight
Terminal:
00=Wo/terminal
Colour: B=Black
G=GRAY

72230-2FCXXXAX00BA1(W)

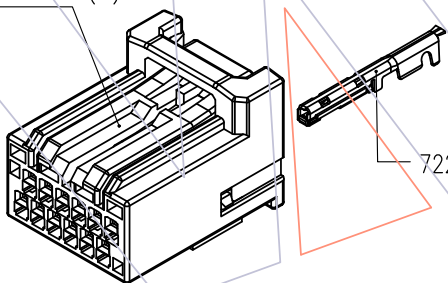

72230-TPSN0X

Matching products:	72230-TPSN02	"S"端
	72230-TPSN01	"M"端
	P/N	ITEM

Client Application:

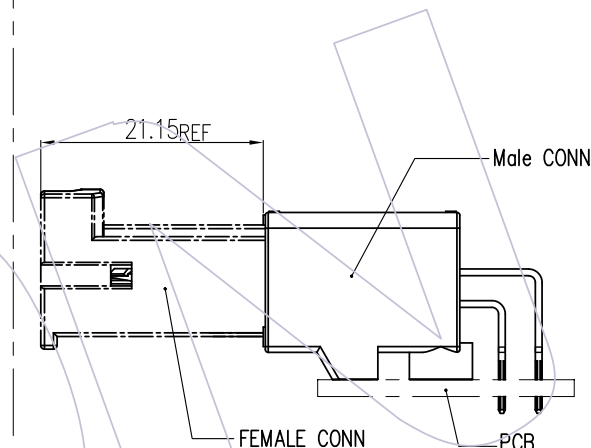
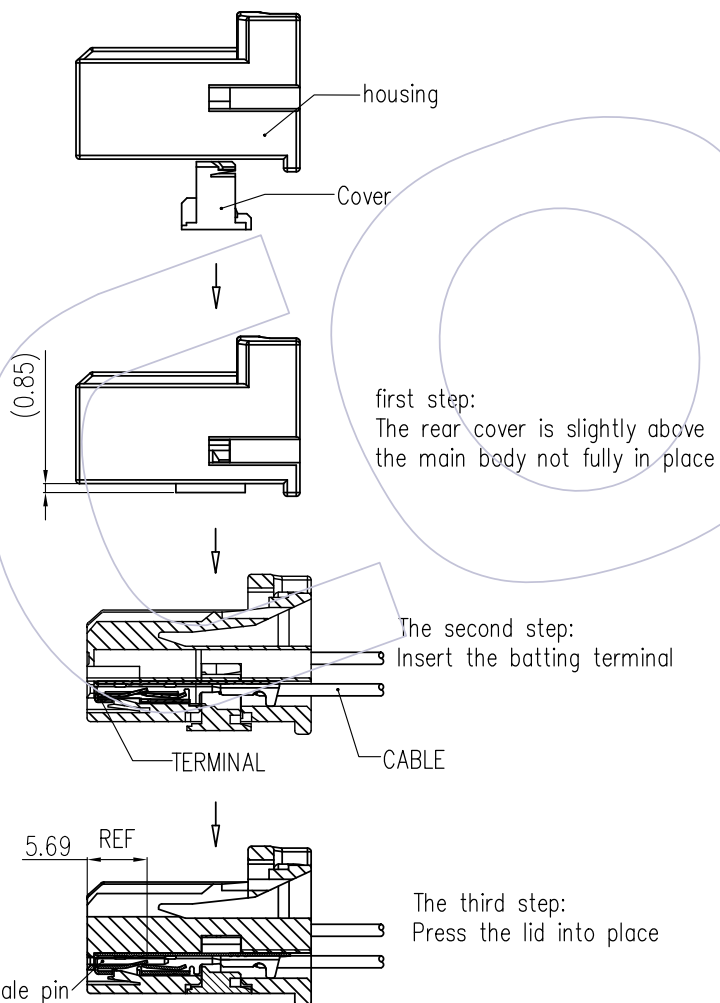

insert before

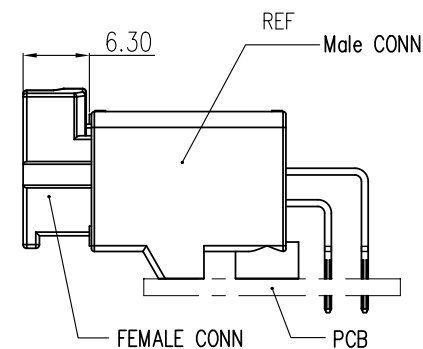

after inserting

Matching products: 72230-2MRXXXAXSNBT1(W)

Alignment diagram

REV	DATE	MODIFICATION DESCRIPTION	CHANGE	OPERATION	DRAW	DATE	SCALE	Fit	PART NO.
A2	2021/09/03	Modify Operation Temperature&Update drawing	Morris	x. ±0.60	Morris	2021/09/03	UNIT	mm [inch]	72230-2FCXXXAX00BA1(W)
A1	2021/03/17	Add W/T WCON SPEC.&P/N	XSR	x.x ±0.40	CHECK	DATE	SIZE	A4	TITLE: 2.2 * 3.0mm Auto-Conn, Dual Row, Female ,Crimp TYPE ,W/C
A0	2021/02/26	NEW	Morris	x.xx ±0.25	APPROVE	DATE	SHEET	2/4	Customer NO.
				Angle ± 3°			PROJ.		
				DIM TOL					

WCON

Http: www.wcon.com

WCON-Dongguan
Tel: +86 769 85358920
Fax: +86 769 85358915
E-mail: sales@wcon.com

WCON-Kunshan
Tel: +86 512 57468408
Fax: +86 512 57468468
E-mail: salesks@wcon.com

HSF

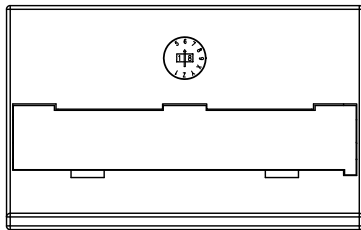
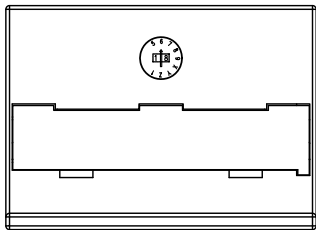
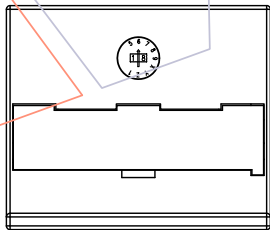
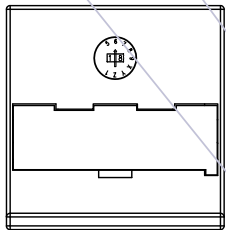
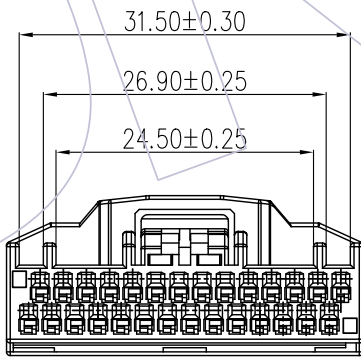
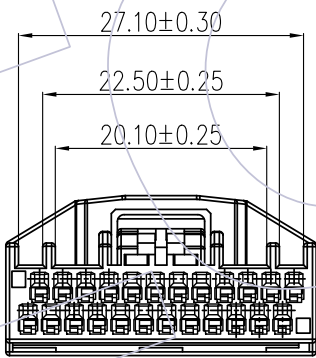
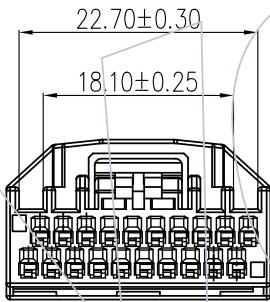
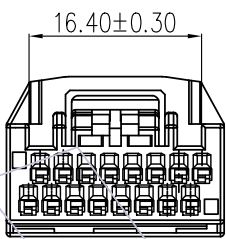
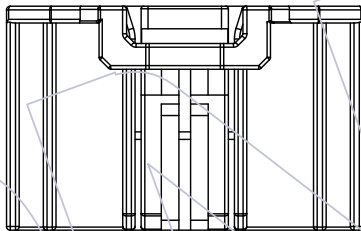
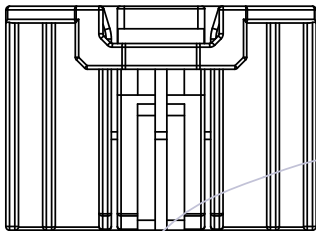
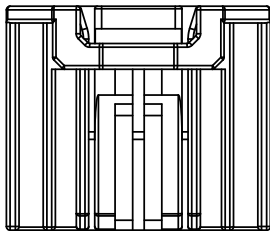
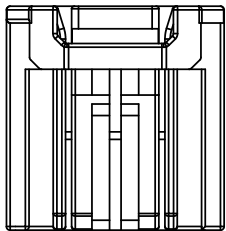

16P

20P

24P

28P

REV	DATE	MODIFICATION DESCRIPTION	CHANGE	OPERATION	DRAW	DATE	SCALE	Fit	PART NO.
A2	2021/09/03	Modify Operation Temperature&Update drawing	Morris	X. ±0.60	Morris	2021/09/03	UNIT	mm [inch]	72230-2FCXXXA00BA1(W)
A1	2021/03/17	Add W/T WCON SPEC.&P/N	XSR	X.X ±0.40	CHECK	DATE	SIZE	A4	TITLE: 2.2 * 3.0mm Auto-Conn, Dual Row, Female ,Crimp TYPE ,W/C
A0	2021/02/26	NEW	Morris	Angle ± 3°	APPROVE	DATE	SHEET	3/4	Customer NO.
				DIM TOL			PROJ.		

WCON

Http: www.wcon.com

WCON-Dongguan Tel: +86 769 85358920 Fax: +86 769 85358915 E-mail: sales@wcon.com	WCON-Kunshan Tel: +86 512 57468408 Fax: +86 512 57468468 E-mail: salesks@wcon.com
---	--

HSF

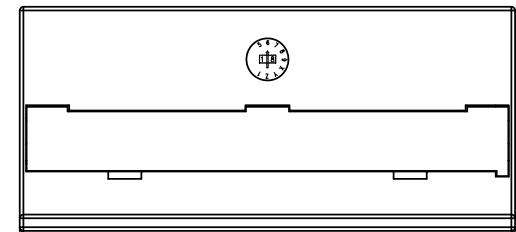
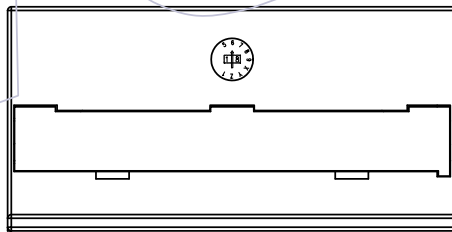
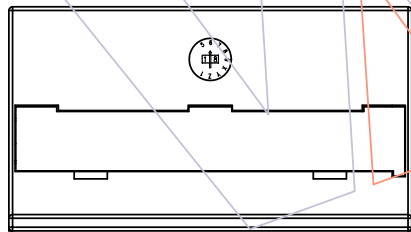
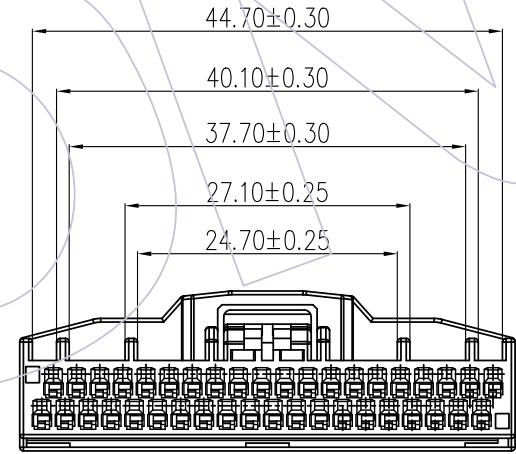
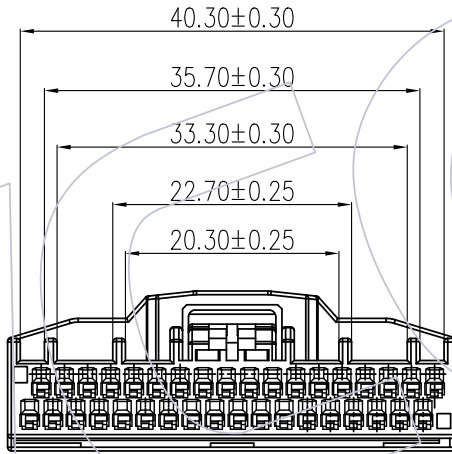
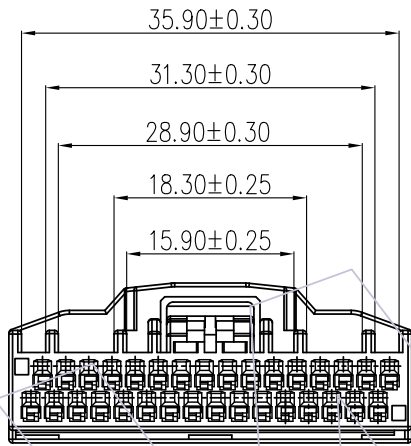
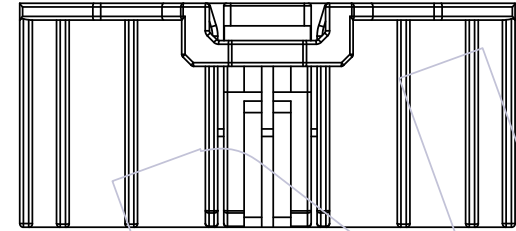
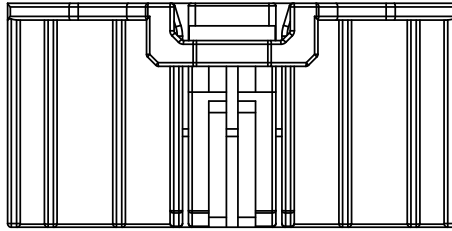
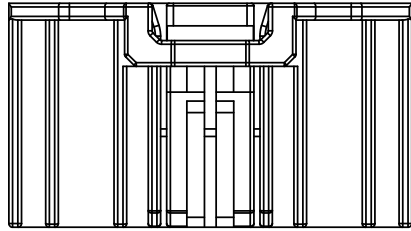

32P

36P

40P

REV	DATE	MODIFICATION DESCRIPTION	CHANGE	OPERATION	DRAW	DATE	SCALE	Fit	PART NO.
A2	2021/09/03	Modify Operation Temperature&Update drawing	Morris	x. ±0.60	Morris	2021/09/03	UNIT	mm [inch]	72230-2FCXXXAX00BA1(W)
A1	2021/03/17	Add W/T WCON SPEC.&P/N	XSR	x.X ±0.40	CHECK	DATE	SIZE	A4	TITLE: 2.2 * 3.0mm Auto-Conn, Dual Row, Female ,Crimp TYPE ,W/C
A0	2021/02/26	NEW	Morris	x.XX ±0.25	APPROVE	DATE	SHEET	4/4	Customer NO.
				Angle ± 3°			PROJ.		
				DIM TOL					

Http: www.wcon.com

WCON-Dongguan Tel: +86 769 85358920 Fax: +86 769 85358915 E-mail: sales@wcon.com	WCON-Kunshan Tel: +86 512 57468408 Fax: +86 512 57468468 E-mail: salesks@wcon.com
---	--