

HSF

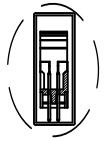

2.0牛角, 180度短耳扣

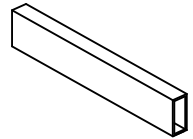

No: 1
产品装入真空管内
SG-A21 (600mm方型真空管)

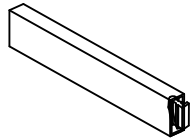

No: 2
塞塑胶塞

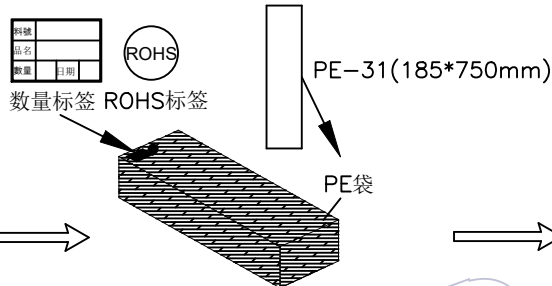

No: 3
20管为一扎套PE-31袋, 内附1包干燥剂
封口机封口, 封箱胶缠绕PE袋两端
再贴标签

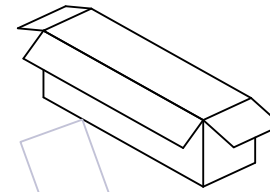

No: 4
真空管装入内箱(2扎/内箱)
内箱规格: CTN-10A(双坑A=B 63*15*15CM)

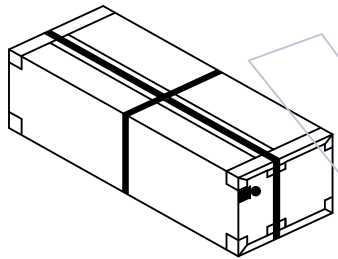

No: 8
打包装带

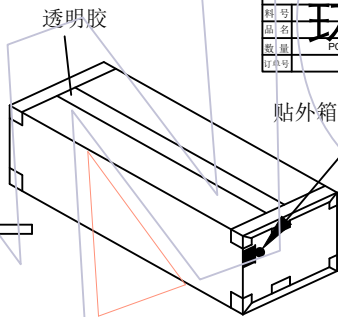

No: 7
封箱及贴标签于外箱侧面的左上角



贴外箱标签及ROHS标签

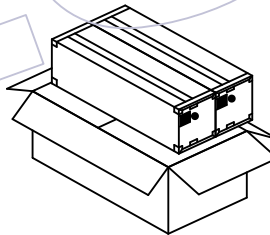

No: 6
内箱放入外箱(2内箱/外箱)
外箱规格: CTN-10C(双坑K=K 65*33*17CM)

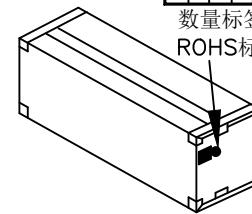

No: 5
封箱及贴标签于内箱侧面的左上角
(40管/内箱)



数量标签及
ROHS标签

| 2.0牛角, 180度短耳扣 | | | | | | | |
|----------------|------------|------------|------------|-----|------------|------------|------------|
| 规格 | 真空管 装数量 | 每内箱 装数量 | 每外箱 装数量 | 规格 | 真空管 装数量 | 每内箱 装数量 | 每外箱 装数量 |
| 6P | 22 | 880 | 1760 | 36P | 10 | 400 | 800 |
| 8P | 20 | 800 | 1600 | 38P | 10 | 400 | 800 |
| 10P | 19 | 760 | 1520 | 40P | 9 | 360 | 720 |
| 12P | 18 | 720 | 1440 | 42P | 9 | 360 | 720 |
| 14P | 17 | 680 | 1360 | 44P | 9 | 360 | 720 |
| 16P | 16 | 640 | 1280 | 46P | 8 | 320 | 640 |
| 18P | 15 | 600 | 1200 | 48P | 8 | 320 | 640 |
| 20P | 14 | 560 | 1120 | 50P | 8 | 320 | 640 |
| 22P | 13 | 520 | 1040 | 52P | 8 | 320 | 640 |
| 24P | 13 | 520 | 1040 | 54P | 7 | 280 | 560 |
| 26P | 12 | 480 | 960 | 56P | 7 | 280 | 560 |
| 28P | 12 | 480 | 960 | 58P | 7 | 280 | 560 |
| 30P | 11 | 440 | 880 | 60P | 7 | 280 | 560 |
| 32P | 11 | 440 | 880 | 62P | 7 | 280 | 560 |
| 34P | 10 | 400 | 800 | 64P | 6 | 240 | 480 |

说明:

1. 产品如图所示型态放入真空管
2. 注意各标签样式, 位置及方向的一致性;
3. 打外箱包装带时需注意, 打为十字型.

变更记事

| 版次 REV | 日期 DATE | 变更说明 MODIFICATION DESCRIPTION | 变更 CHANGE | 核准 APPROVE | 零件图 | | 颜色 COLOR | 材质 MATERIAL | 设计 DESING | 审核 CHECK | 核准 核淮 | SCALE | 1:1 |
|-----------|------------|----------------------------------|--------------|---------------|-------|-------|-------------|----------------|--------------|-------------|----------|-------|-----|
| | | | | | X. | TOL | | | | | | | |
| A1 | 10/08/18 | 原盒装现变更为管装 | | | X.X | ±0.20 | | | 马云青 | 10/08/18 | | UNIT | mm |
| A0 | 09/08/28 | NEW | | | X.XX | ±0.10 | | | Tang | 10/08/18 | | SIZE | A4 |
| | | | | | X.XXX | ±0.05 | | | Zhou | 10/08/18 | | SHEET | 1/1 |
| | | | | | Angle | | | | | | | PROJ. | ☉ |
| | | | | | X. | ± 2' | | | | | | | |

WCON

WCON Hardware Electronics Co., Ltd

料号 PART NO. 3220-XXSXXBST1

品名 TITLE: 2.0牛角 180度 短耳扣 包装规范