

HSF

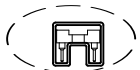

2.54mm IC SOCKET
180 H=3.0 L=7.43

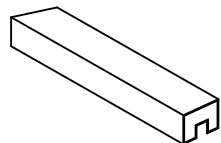

No: 1

产品装入真空管内
SG-C14 (635mm方型真空管)

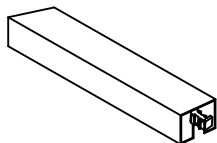

No: 2

塞密封胶塞



数量标签 ROHS标签

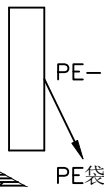

PE-31(185*750mm)

PE袋

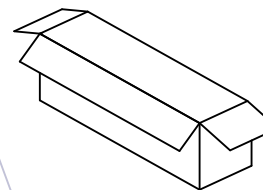

No: 3

20管为一扎套PE-31袋中, 内附1包干燥剂
封口机封口, 封箱胶缠绕PE袋两端
再贴标签

No: 4

真空管装入内箱(5扎/内箱)
内箱规格: CTN-02A(双坑A=B 66.5*12*13.5CM)

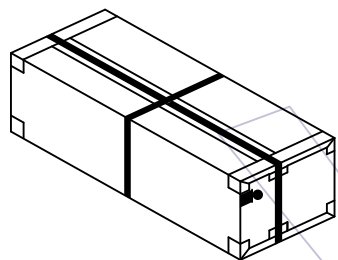

No: 8

打包装带

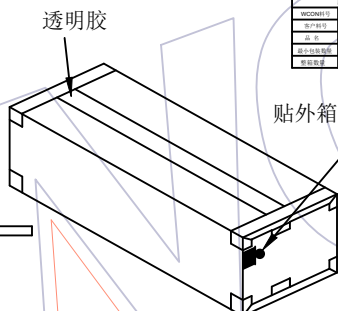

No: 7

封箱及贴标签于外箱侧面的左上角

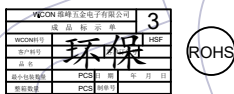

贴外箱标签及ROHS标签

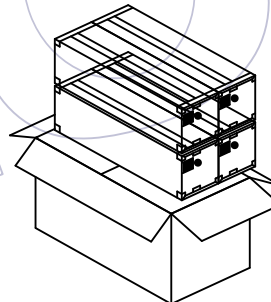

No: 6

内箱放入外箱(4内箱/外箱)
外箱规格: CTN-02H(双坑K=K 69.5*30*30CM)

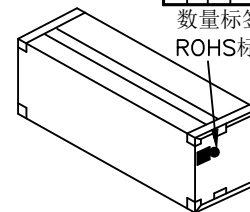

No: 5

封箱及贴标签于内箱侧面的左上角
(100管/内箱)



数量标签及
ROHS标签

规格	真空管 装数量	每内箱 装数量	每外箱 装数量
6P(2*3P)	80	8000	32000
8P(2*4P)	60	6000	24000
10P(2*5P)	48	4800	19200
14P(2*7P)	34	3400	13600
16P(2*8P)	30	3000	12000
18P(2*9P)	26	2600	10400
20P(2*10P)	24	2400	9600
22P(2*11P)	22	2200	8800
24P(2*12P)	20	2000	8000
28P(2*14P)	17	1700	6800

说明:

1. 产品如图所示型态放入真空管;
2. 注意各标签样式、位置及方向的一致性;
3. 打外箱包装带时需注意, 打为十字型;

变更记事

版次 REV	日期 DATE	变更说明 MODIFICATION DESCRIPTION	变更 CHANGE	核准 APPROVE
A0	10/06/23	NEW		

零件图		颜色 COLOR	材质 MATERIAL	设计 DESING	审核 CHECK	核准 APPROVE
X.				马云青	10/06/23	
X.X	±0.20					
X.XX	±0.10					
X.XXX	±0.05					
Angle						
X.	± 2'					
DIM	TOL					

SCALE	1:1
UNIT	mm
SIZE	A4
SHEET	1/1
PROJ.	

WCON ELECTRONICS (GUANGDONG) CO. LTD	
料号 PART NO.	7110-301XXSXX074T1
品名 TITLE:	2.54mm IC SOCKET 180 H=3.0 L=7.43