

HSF

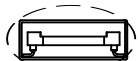

2.54mm IC SOCKET
SMT H=3.0 L=7.43

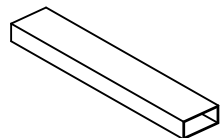

No: 1

产品装入真空管内
SG-A21 (600mm方型真空管)

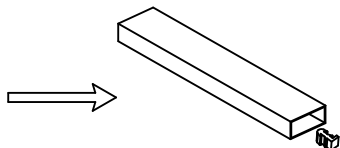

No: 2

塞塑胶塞



PE-31(185*750mm)

PE袋

数量标签 ROHS标签

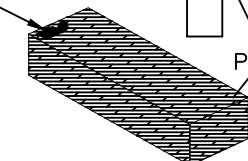

No: 3

20管为一扎套PE-31袋中, 内附1包干燥剂
封口机封口, 封箱胶缠绕PE袋两端
再贴标签

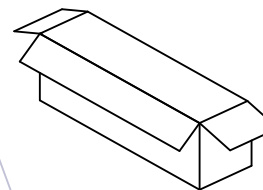

No: 4

真空管装入内箱(4扎/内箱)
内箱规格: CTN-10A(双坑A=B 63*15*17CM)

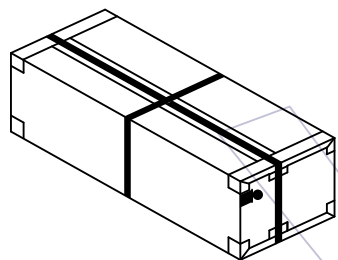

No: 8

打包装带

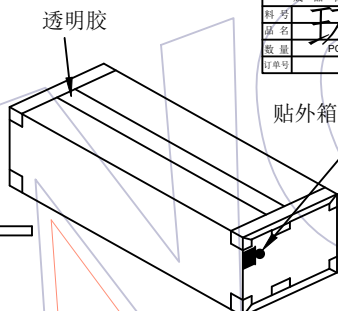

No: 7

封箱及贴标签于外箱侧面的左上角

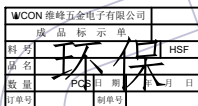

贴外箱标签及ROHS标签

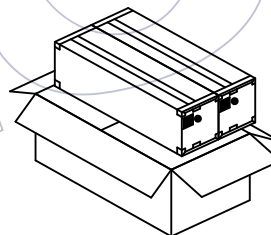

No: 6

内箱放入外箱(2内箱/外箱)
外箱规格: CTN-10C(双坑K=K 65*33*19CM)

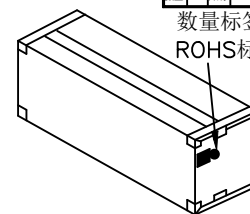

No: 5

封箱及贴标签于内箱侧面的左上角
(80管/内箱)



数量标签及
ROHS标签

2.54mm IC SOCKET SMT H=3.0 L=7.43			
规格	真空管 装数量	每内箱 装数量	每外箱 装数量
24P	19	1520	3040
28P	16	1280	2560
32P	14	1120	2240
36P	12	960	1920
40P	11	880	1760
42P	10	800	1600
48P	9	720	1440

说明:

1. 产品如图所示型态放入真空管;
2. 注意各标签样式、位置及方向的一致性;
3. 打外箱包装带时需注意, 打为十字型;

变更记事

版次 REV	日期 DATE	变更说明 MODIFICATION DESCRIPTION	变更 CHANGE	核准 APPROVE
A0	10/06/23	NEW		

零件图		颜色 COLOR	SCALE	1:1
X.			UNIT	mm
X.X	±0.20	材质 MATERIAL	SIZE	A4
X.XX	±0.10	设计 DESING	SHEET	1/1
X.XXX	±0.05	审核 CHECK	PROJ.	
Angle		核准 APPROVE		
X.	± 2'			
DIM	TOL			

SCALE		1:1		
UNIT		mm		
SIZE		A4	WCON ELECTRONICS (GUANGDONG) CO. LTD	
SHEET		1/1	料号 PART NO.	7110-302XXMXX074TX
PROJ.			品名 TITLE:	2.54mm IC SOCKET SMT H=3.0 L=7.43

马云青 10/06/23