

HSF

NOTES:

- 1.Current Rating: 3.2A per pin;
- 2.Contact Resistance: 20mΩ Max;
- 3.Withstand Voltage: 500V AC/DC;
- 4.Insulation Resistance: 1000MΩ Min at 500V DC;
- 5.Operating Temperature: -55°C to +125°C;
- 6.Insulator(Housing&Cover)Material: LCP,G.F,UL94V-0,BK;
- 7.Contact Material:Copper Alloy;
- 8.Contact plating:
xxμ" Gold on contact area
(See ordering information),
100μ" Matte TIN on solder area,
50μ" Nickel underplating overall;
- 9.Recommended process:
IR soldering,
Peak temperature:260±5°C, 5s ;

T
1.50
2.00
3.00
5.00

Ordering Information

3703 - A XXX - XXX M XX X 01

TYPE
COMBO Pulg/Socket

No.of Positions
005:5PIN
010:10PIN (5P-30P)

Insulator Height
065:6.54mm

Contact Shape
M:SMT
S:180 DIP
R:90 DIP

Internal Code
01:With post
02:Without post

Packing:
T:Tube
R:Tape&Reel

Contact Plating:
W0=Gold Flash/Matte Tin
W3=10u" Gold/Matte Tin
W5=30u" Gold/Matte Tin

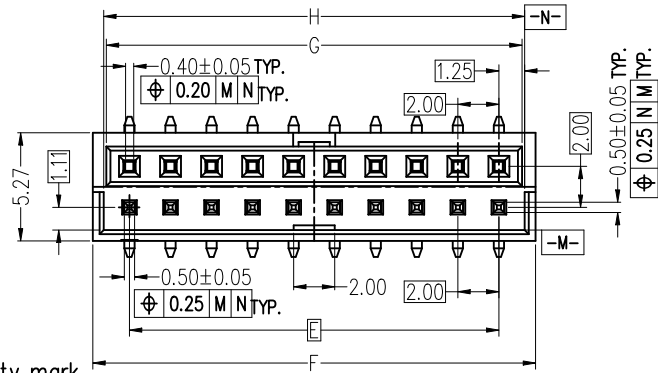

Polarity mark position

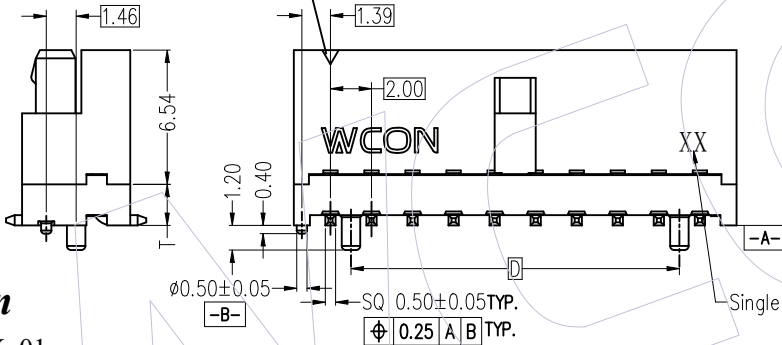

Single Row Pin

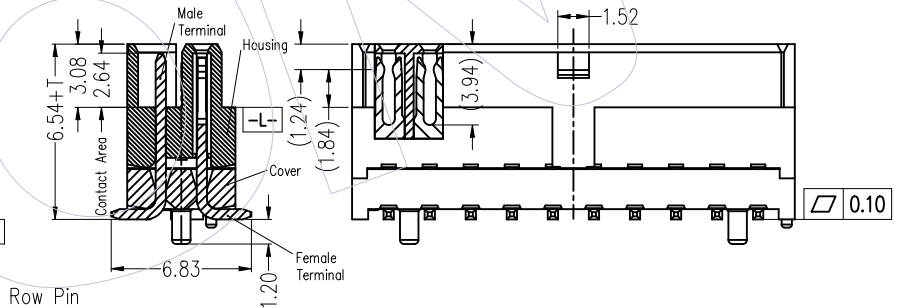

Polarity mark position

PCB Layout
(PCB BOARD TOLERANCE±0.05)

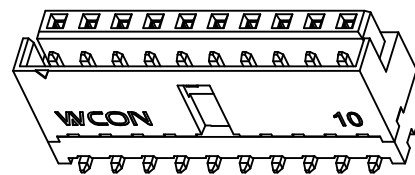
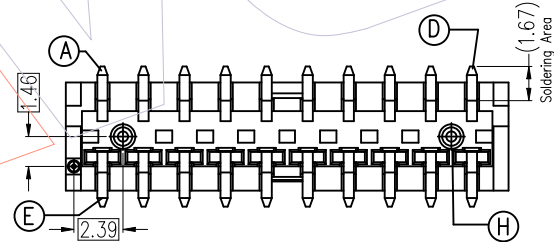

Pin	D	E	F	G	H
2*05	6.00	8.00	11.57 ^{+0.20} _{-0.20}	10.25 ^{+0.08} _{-0.20}	10.51 ^{+0.20} _{-0.08}
2*06	8.00	10.00	13.57 ^{+0.20} _{-0.20}	12.25 ^{+0.08} _{-0.25}	12.51 ^{+0.25} _{-0.08}
2*08	12.00	14.00	17.57 ^{+0.25} _{-0.25}	16.25 ^{+0.08} _{-0.25}	16.51 ^{+0.25} _{-0.08}
2*10	16.00	18.00	21.57 ^{+0.25} _{-0.25}	20.25 ^{+0.10} _{-0.30}	20.51 ^{+0.25} _{-0.10}
2*13	22.00	24.00	27.57 ^{+0.25} _{-0.25}	26.25 ^{+0.10} _{-0.30}	26.51 ^{+0.30} _{-0.10}
2*15	26.00	28.00	31.57 ^{+0.30} _{-0.30}	30.25 ^{+0.10} _{-0.30}	30.51 ^{+0.30} _{-0.10}
2*20	36.00	38.00	41.57 ^{+0.30} _{-0.30}	40.25 ^{+0.10} _{-0.30}	40.51 ^{+0.30} _{-0.10}
2*30	56.00	58.00	61.57 ^{+0.30} _{-0.30}	60.25 ^{+0.10} _{-0.30}	60.51 ^{+0.30} _{-0.10}

OPERATION	DRAW	DATE	SCALE	FIT	PART NO.
x.x ±0.40	Kair	2021/08/21	UNIT	mm	3703-AXXX-XXXMXX01
x.xx ±0.25	CHECK	DATE	SIZE	A4	TITLE:
x.xxx ±0.15	APPROVE	DATE	SHEET	1/3	2.00mm 公母合体连接器 180度SMT TYPE
Angle ± 3°			PROJ.	Customer NO.	
DIM TOL					

WCON

Http: www.wcon.com

WCON-Dongguan
Tel: +86 769 85358920
Fax: +86 769 85358915
E-mail: sales@wcon.com

WCON-Kunshan
Tel: +86 512 57468408
Fax: +86 512 57468468
E-mail: salesks@wcon.com

REV	DATE	MODIFICATION DESCRIPTION	CHANGE
A0	2021/08/21	NEW	Kair

HSF

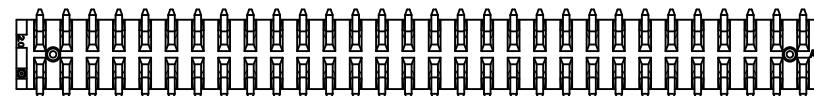
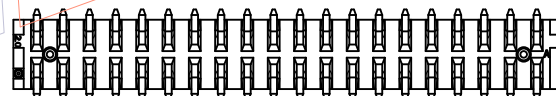
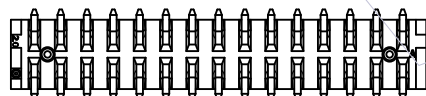
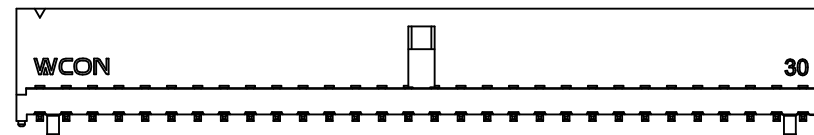
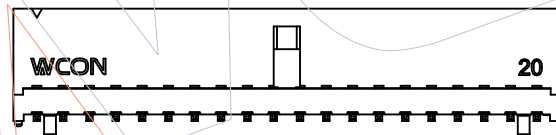
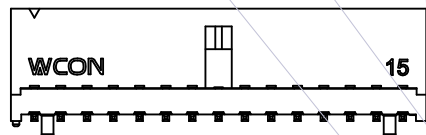
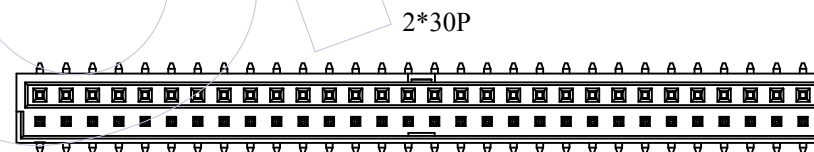
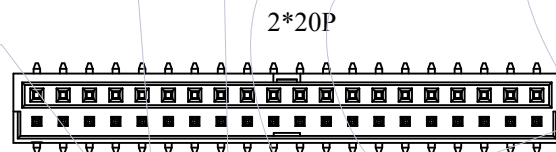
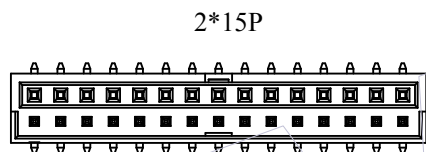
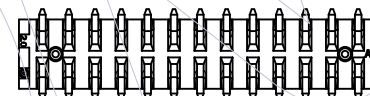
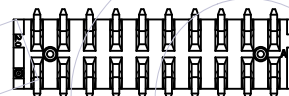
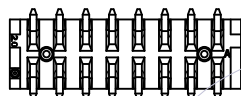
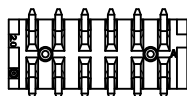
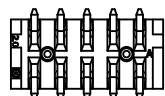
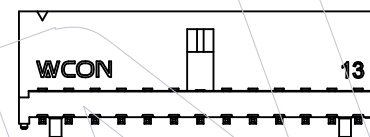
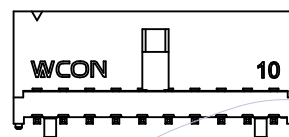
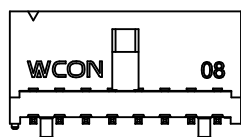
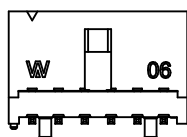
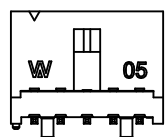
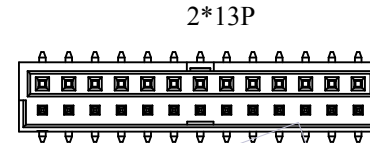
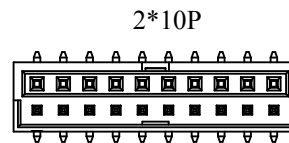
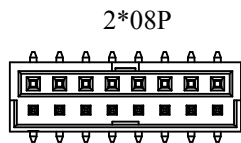
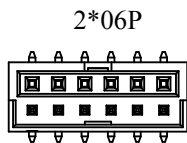
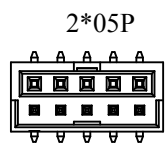

				OPERATION	DRAW	DATE	SCALE	FIT	PART NO.
				x.x ±0.40	Kair	2021/08/21	UNIT	mm	3703-AXXX-XXXMXX01
				x.xx ±0.25	CHECK	DATE	SIZE	A4	TITLE:
				x.xxx ±0.15	APPROVE	DATE	SHEET	2/3	2.00mm 公母合体连接器
A0	2021/08/21	NEW	Kair	Angle ± 3°			PROJ.	⌀	180度DIP TYPE
REV	DATE	MODIFICATION DESCRIPTION	CHANGE	DIM TOL					Customer NO.

WCON

Http: www.wcon.com

WCON-Dongguan	WCON-Kunshan
Tel: +86 769 85358920	Tel: +86 512 57468408
Fax: +86 769 85358915	Fax: +86 512 57468468
E-mail: sales@wcon.com	E-mail: salesks@wcon.com

HSF

Application and assembly

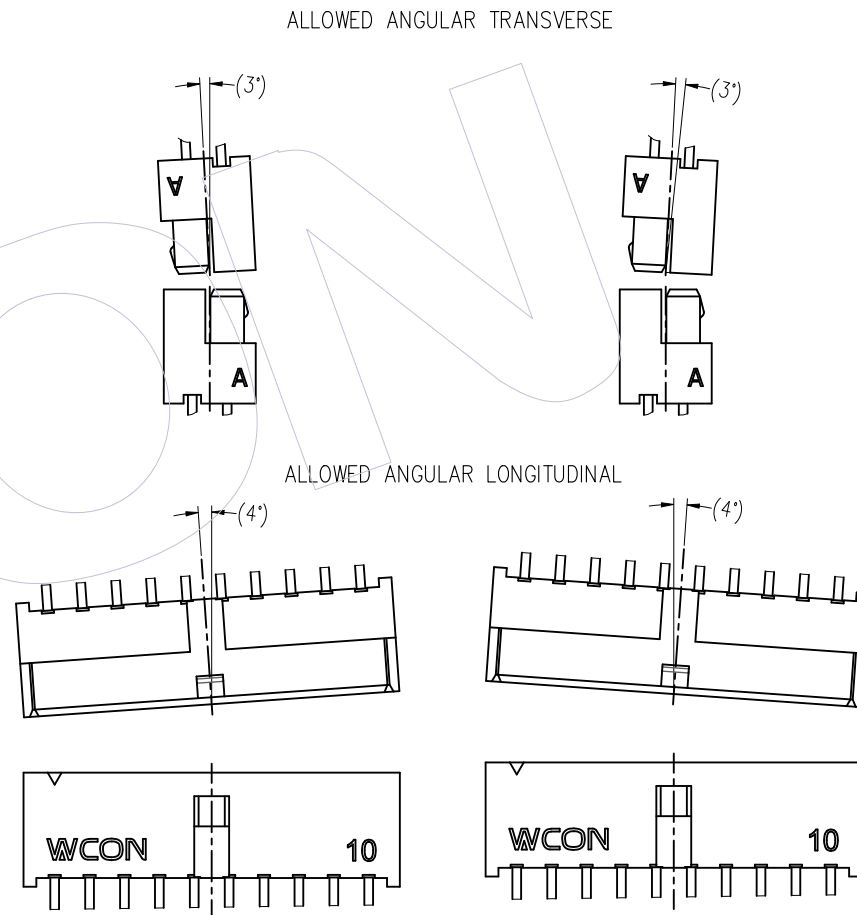
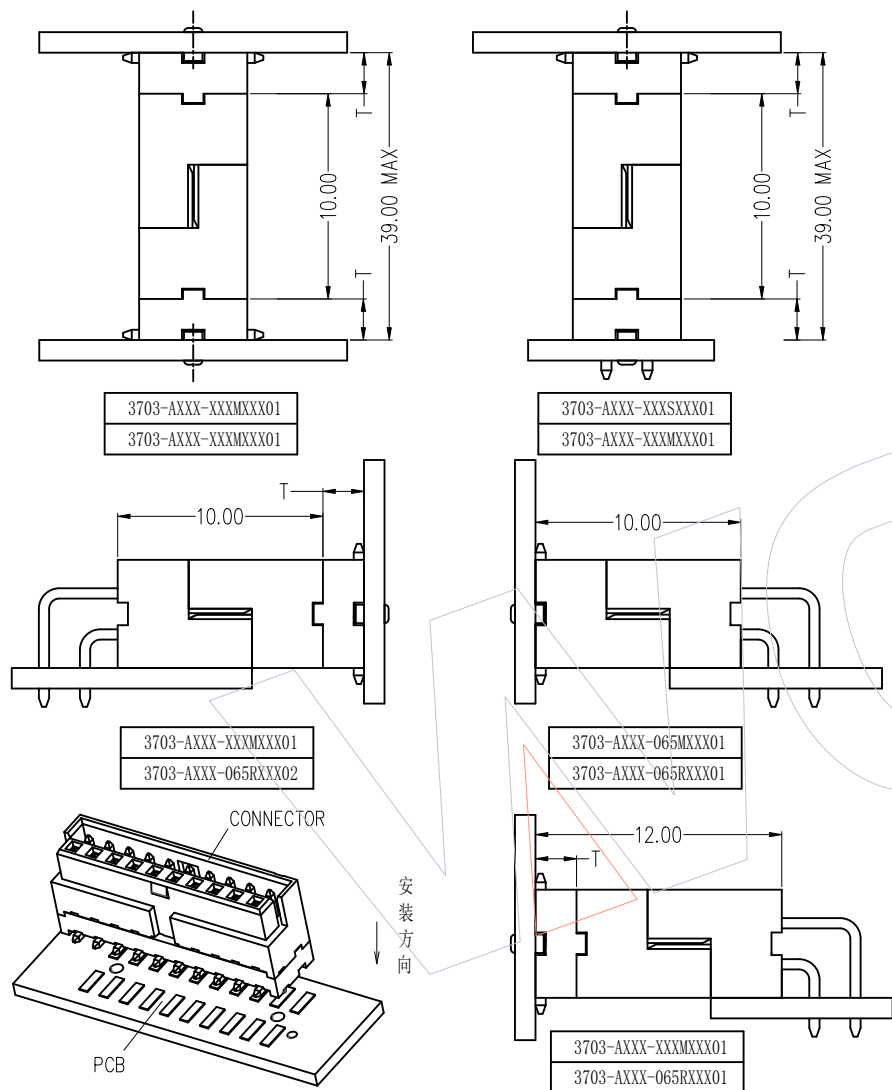

				OPERATION	DRAW	DATE	SCALE	FIT	PART NO.
				x.x ±0.40	Kair	2021/08/21	UNIT	mm inch	3703-AXXX-XXXXXX01
				x.xx ±0.25	CHECK	DATE	SIZE	A4	TITLE:
A0	2021/08/21	NEW	Kair	x.xxx ±0.15			SHEET	3/3	2.00mm 公母合体连接器 180度DIP TYPE
REV	DATE	MODIFICATION DESCRIPTION	CHANGE	Angle ± 3°	APPROVE	DATE	PROJ.	⊕	Customer NO.
				DIM TOL					

WCON

Http: www.wcon.com

WCON-Dongguan	WCON-Kunshan
Tel: +86 769 85358920	Tel: +86 512 57468408
Fax: +86 769 85358915	Fax: +86 512 57468468
E-mail: sales@wcon.com	E-mail: salesks@wcon.com