

HSF

NOTES:

Current Rating: 3.2AMP Per Pin(2 Pins Powered)
 Voltage Rating: 250VAC
 Contact Resistance: 30mΩ Max
 Withstand Voltage: 750V AC
 Insulation Resistance: 1000MΩ Min
 Operation Temperature: -55℃ to +125℃
 Contact Material: Copper Alloy
 Contact plating:
 XXu" Gold On Contact Area,
 (See Ordering Information)
 100u" Matte Tin On Solder Area
 50u" Nickel Underplating Overall
 Insulator And Cap Material: LCP,G.F,UL94V-0,Black

Recommended Process:
 Wave Soldering, Peak Temperature: 260±5℃
 For 5+/-1s

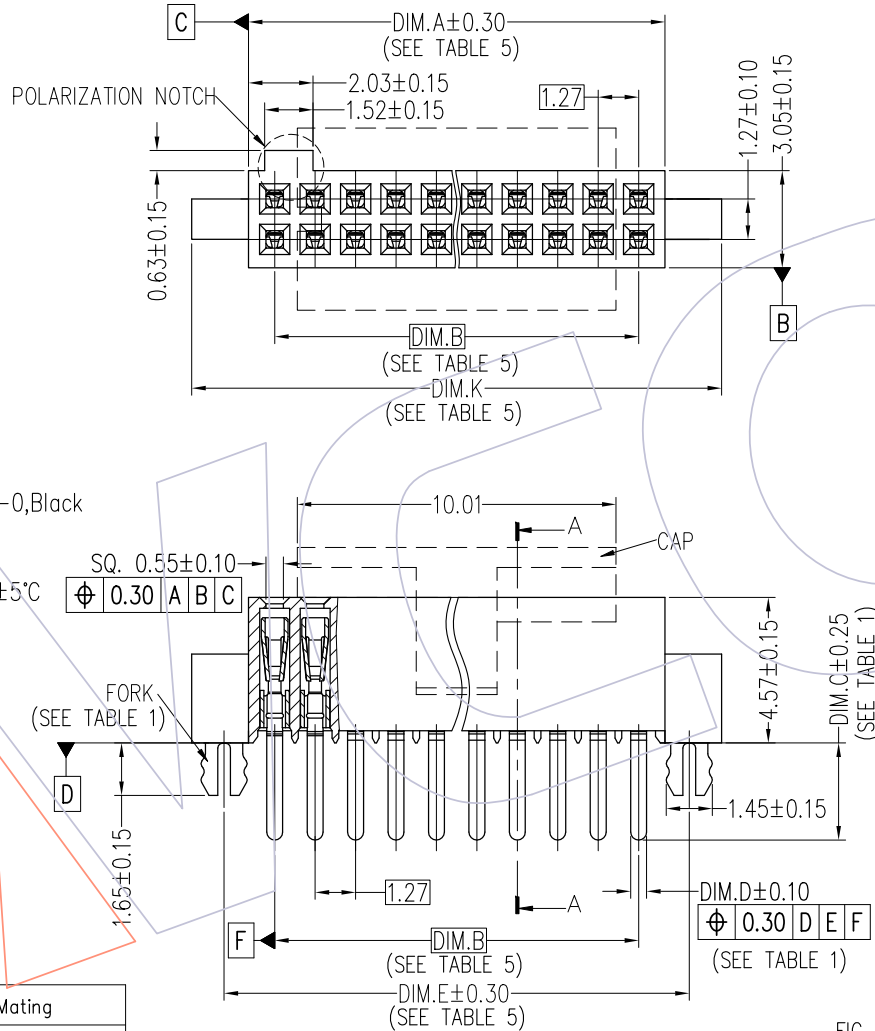

TABLE 1

PART NO.	Lead Style	DIM.C	DIM.D	Fork
3601-SXXX-CX1SXXX01	-01	3.05	0.50	Yes
3601-SXXX-CX1SXXX11	-03	1.91	0.41	Yes
3601-SXXX-CX1SXXX02	-01	3.05	0.50	No
3601-SXXX-CX1SXXX12	-03	1.91	0.41	No

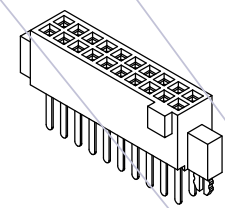

TABLE 2

Item	Pitch	Mating
Standard	1.27	3601-P
Alternative		

FIG. 1
 THROUGH HOLE/STRAIGHT MODIFIED(-STD)
 LEAD STYLE: -01, -03

REV	DATE	MODIFICATION DESCRIPTION	CHANGE	OPERATION	DRAW	DATE	SCALE	FIT	PART NO.
AO	2021/10/20	NEW	Ken	x.x ±0.40	Ken	2021/10/20	UNIT	mm	3601-SXXX-CX1SXXXXX
				x.xx ±0.25	CHECK	DATE	SIZE	A4	TITLE:
				x.xxx ±0.15	APPROVE	DATE	SHEET	1/8	1.27mm BTB Female Header W=3.05, -LC STYLE, DIP
				Angle ± 3°			PROJ.	Customer NO.	
				DIM TOL					

WCON
 Http: www.wcon.com

WCON-Dongguan
 Tel: +86 769 85358920
 Fax: +86 769 85358915
 E-mail: sales@wcon.com

WCON-Kunshan
 Tel: +86 512 57468408
 Fax: +86 512 57468468
 E-mail: salesks@wcon.com

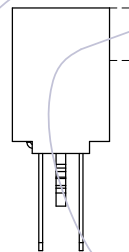
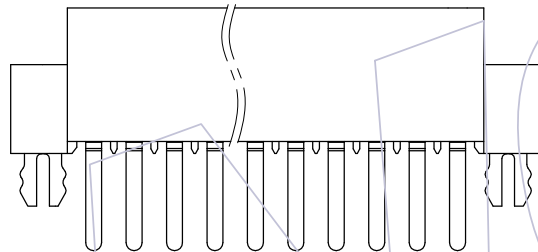
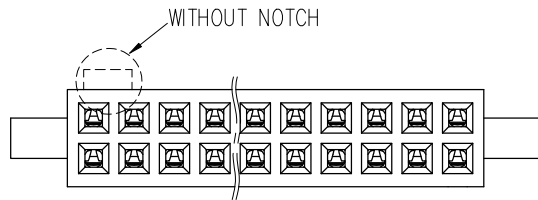

Recommended P.C.B Layout (Top Side)
(PCB BOARD TOLERANCE ±0.05)

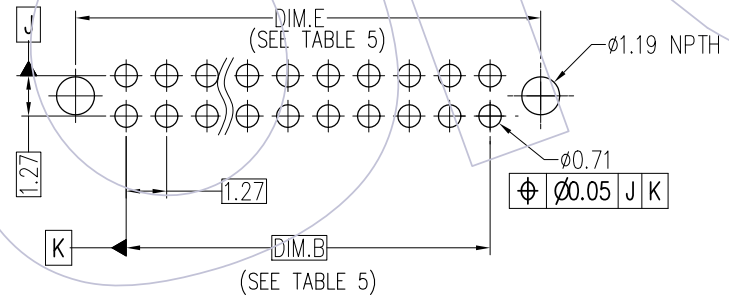

FIG. 2
WITHOUT NOTCH
(SAME AS FIG.1, DIFFERENT AS SHOWN)

				OPERATION	DRAW	DATE	SCALE	FIT	PART NO.
				x.x ±0.40	Ken	2021/10/20	UNIT	mm	3601-SXXX-CX1SXXXXX
				x.xx ±0.25	CHECK	DATE	SIZE	A4	TITLE:
AO	2021/10/20	NEW	Ken	x.xxx ±0.15	APPROVE	DATE	SHEET	2/8	1.27mm BTB Female Header W=3.05, -LC STYLE, DIP
REV	DATE	MODIFICATION DESCRIPTION	CHANGE	Angle ± 3°			PROJ.	Customer NO.	
				DIM TOL					

WCON

Http: www.wcon.com

WCON-Dongguan	WCON-Kunshan
Tel: +86 769 85358920	Tel: +86 512 57468408
Fax: +86 769 85358915	Fax: +86 512 57468468
E-mail: sales@wcon.com	E-mail: salesks@wcon.com

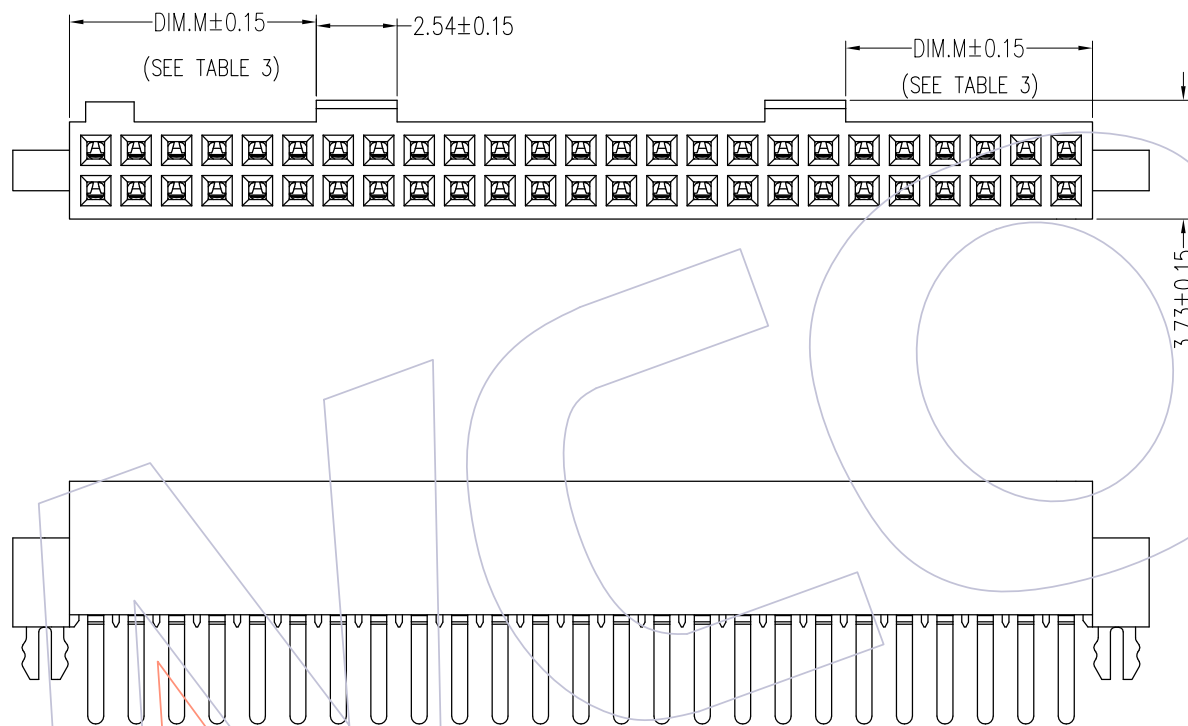

TABLE 3

NO. OF POS.	DIM.M
05, 07, 08	2.03
10 THRU 50	7.75

FIG. 3
HOUSING WITH LOCKING
POSITION 25 PER ROW
(SAME AS FIG.1, DIFFERENT AS SHOWN)



				OPERATION	DRAW	DATE	SCALE	FIT	PART NO.	 Http: www.wcon.com WCON-Dongguan Tel: +86 769 85358920 Fax: +86 769 85358915 E-mail: sales@wcon.com	WCON-Kunshan Tel: +86 512 57468408 Fax: +86 512 57468468 E-mail: salesks@wcon.com
			x.x	±0.40	Ken	2021/10/20	UNIT	mm	3601-SXXX-CX1SXXXXX		
			x.xx	±0.25	CHECK	DATE	SIZE	A4	TITLE:		
AO	2021/10/20	NEW	Ken	±0.15	APPROVE	DATE	SHEET	3/8	1.27mm BTB Female Header W=3.05, -LC STYLE, DIP		
REV	DATE	MODIFICATION DESCRIPTION	CHANGE	Angle	± 3°		PROJ.	Customer NO.			
				DIM	TOL						

TABLE 4

No.	Pin Number (Per Row)	POLARIZATION	BUMP LOCKING A	BUMP LOCKING B	BUMP LOCKING C
4	2*5,2*7,2*8	NO	YES	NO	NO
3	2*10-2*24	YES	YES	NO	NO
3	2*25-2*34	YES	YES	YES	NO
3	2*35-2*50	YES	YES	YES	YES
2	ALL	NO	NO	NO	NO
1	2*5-2*50	YES	NO	NO	NO

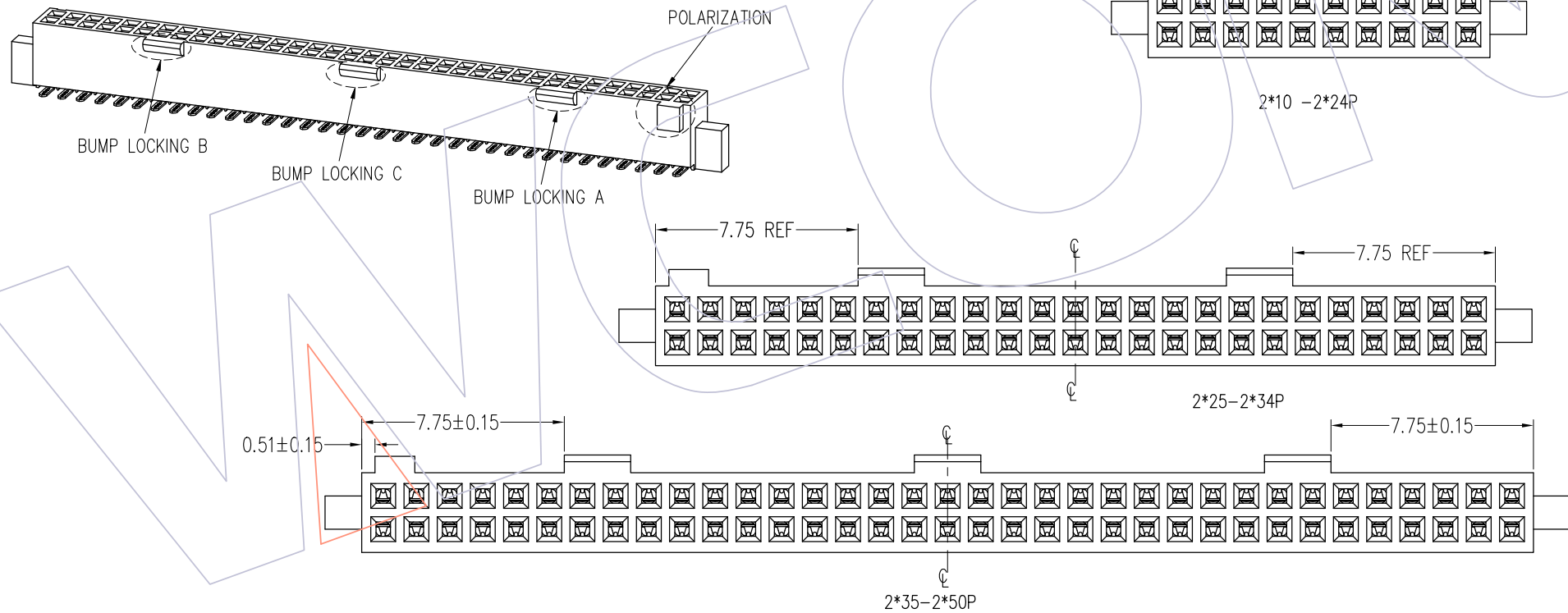

				OPERATION	DRAW	DATE	SCALE	FIT	PART NO.	 Http: www.wcon.com WCON-Dongguan Tel: +86 769 85358920 Fax: +86 769 85358915 E-mail: sales@wcon.com	WCON-Kunshan Tel: +86 512 57468408 Fax: +86 512 57468468 E-mail: salesks@wcon.com
			x.x ±0.40	Ken	2021/10/20	UNIT	mm	3601-SXXX-CX1SXXXXX			
			x.xx ±0.25	CHECK	DATE	SIZE	A4	TITLE: 1.27mm BTB Female Header W=3.05, -LC STYLE, DIP			
AO	2021/10/20	NEW	x.xxx ±0.15	APPROVE	DATE	SHEET	4/8	Customer NO.			
REV	DATE	MODIFICATION DESCRIPTION	DIM	TOL			PROJ.				

HSF

Ordering Information

3601 - S XXX -C X1S XX X XX

No.Of Pins:
04-100Pin
(See Table 5)

Housing Character:

- 1= Notch+No Bump Locking
 - 2= No Notch+No Bump Locking
 - 3= Notch+ Bump Locking
 - 4= No Notch + Bump Locking
- (SEE TABLE 4)

Internal Code:

01= 180°DIP

Tail Length 3.05mm, Fork

11= 180°DIP

Tail Length 1.91mm, Fork

02= 180°DIP

Tail Length 3.05mm, No Fork

12= 180°DIP

Tail Length 1.91mm, No Fork

(See Table 1)

Packaging :



- R=Tape & Reel+ Cap
- T=Tube
- P=Tube + Cap

Contact Plating:

- W1=3u" Gold/Matte Tin
- W2=5u" Gold/Matte Tin
- W3=10u" Gold/Matte Tin
- W4=15u" Gold/Matte Tin
- W5=30u" Gold/Matte Tin

TABLE 5:

PIN No.(HOUSING WITH LOCKING)	PIN No.(HOUSING WITHOUT LOCKING)	Part Number	DIM.A	DIM.B	DIM.E	DIM.K
NA	4(2*2P)	3601-S004-CX1SXXXXX	2.92	1.27	4.45	6.48
NA	6(2*3P)	3601-S006-CX1SXXXXX	4.19	2.54	5.72	7.75
NA	8(2*4P)	3601-S008-CX1SXXXXX	5.46	3.81	6.99	9.02
10(2*5P)	10(2*5P)	3601-S010-CX1SXXXXX	6.73	5.08	8.26	10.29
NA	12(2*6P)	3601-S012-CX1SXXXXX	8.00	6.35	9.53	11.56
14(2*7P)	14(2*7P)	3601-S014-CX1SXXXXX	9.27	7.62	10.80	12.83
16(2*8P)	16(2*8P)	3601-S016-CX1SXXXXX	10.54	8.89	12.07	14.10
20(2*10P)	20(2*10P)	3601-S020-CX1SXXXXX	13.08	11.43	14.61	16.64
30(2*15P)	30(2*15P)	3601-S030-CX1SXXXXX	19.43	17.78	20.96	22.99
40(2*20P)	40(2*20P)	3601-S040-CX1SXXXXX	25.78	24.13	27.31	29.34
50(2*25P)	50(2*25P)	3601-S050-CX1SXXXXX	32.13	30.48	33.66	35.69
60(2*30P)	60(2*30P)	3601-S060-CX1SXXXXX	38.48	36.83	40.01	42.04
70(2*35P)	70(2*35P)	3601-S070-CX1SXXXXX	44.83	43.18	46.36	48.39
80(2*40P)	80(2*40P)	3601-S080-CX1SXXXXX	51.18	49.53	52.71	54.74
90(2*45P)	90(2*45P)	3601-S090-CX1SXXXXX	57.53	55.88	59.06	61.09
100(2*50P)	100(2*50P)	3601-S100-CX1SXXXXX	63.88	62.23	65.41	67.44

OPERATION		DRAW		DATE		SCALE		FIT		PART NO.		 Http: www.wcon.com	
x.x	±0.40	Ken	2021/10/20	UNIT	mm	3601-SXXX-CX1SXXXXX		TITLE:					
x.xx	±0.25	CHECK	DATE	SIZE	A4	1.27mm BTB Female Header W=3.05, -LC STYLE, DIP		Customer NO.		WCON-Dongguan		WCON-Kunshan	
x.xxx	±0.15	APPROVE	DATE	SHEET	5/8					Tel: +86 769 85358920		Tel: +86 512 57468408	
Angle	± 3'			PROJ.						Fax: +86 769 85358915		Fax: +86 512 57468468	
DIM	TOL									E-mail: sales@wcon.com		E-mail: salesks@wcon.com	
AO	2021/10/20	NEW	Ken										
REV	DATE	MODIFICATION DESCRIPTION	CHANGE										

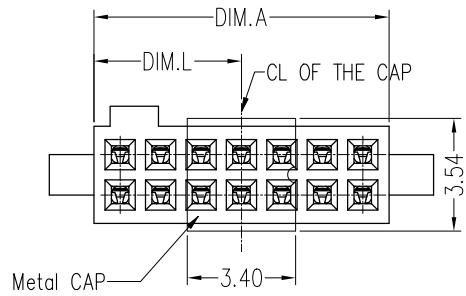

Housing Character	PIN No.	DIM.L
No Notch+No Bump Locking	2*2P~2*7P	DIM.L=1/2*DIM.A
Notch+No Bump Locking	2*5P	DIM.L=3.73
	2*6P~2*7P	DIM.L=1/2*DIM.A

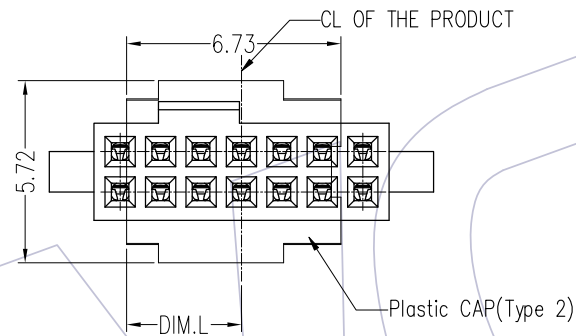

Housing Character	PIN No.	DIM.L
No Notch + Bump Locking	2*5P	DIM.L=3.37
	2*7P	DIM.L=3.61
	2*8P	DIM.L=4.24
Notch+ Bump Locking	2*35~2*50P	DIM.L=2.97

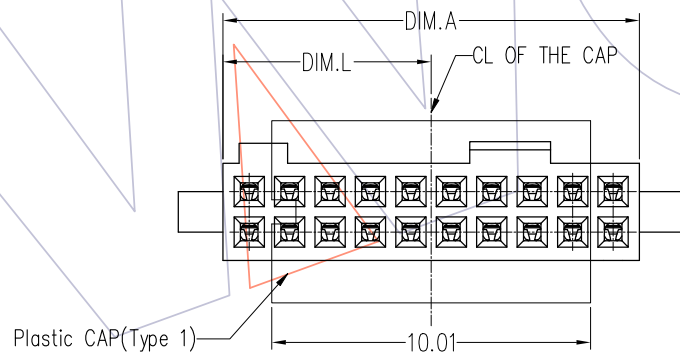

Housing Character	PIN No.	DIM.L
No Notch+No Bump Locking	2*8P~2*50P	DIM.L=1/2*DIM.A
Notch+No Bump Locking	2*8P~2*50P	DIM.L=1/2*DIM.A
Notch+ Bump Locking	2*10P~2*13P	DIM.L=6.48
	2*14P~2*17P	DIM.L=11.56
	2*18P~2*34P	DIM.L=1/2*DIM.A

REV	DATE	MODIFICATION DESCRIPTION	CHANGE	OPERATION	DRAW	DATE	SCALE	FIT	PART NO.
AO	2021/10/20	NEW	Ken	x.x ±0.40	Ken	2021/10/20	UNIT	mm	3601-SXXX-CX1SXXXXX
				x.xx ±0.25	CHECK	DATE	SIZE	A4	TITLE:
				x.xxx ±0.15	APPROVE	DATE	SHEET	6/8	1.27mm BTB Female Header W=3.05, -LC STYLE, DIP
				Angle ± 3°			PROJ.	Customer NO.	
				DIM TOL					

WCON

Http: www.wcon.com

WCON-Dongguan

Tel: +86 769 85358920

Fax: +86 769 85358915

E-mail: sales@wcon.com

WCON-Kunshan

Tel: +86 512 57468408

Fax: +86 512 57468468

E-mail: salesks@wcon.com

HSF

TABLE 6:

		ASS'Y HIGH(H)		MALE	FEMALE	WIPE			
		3601-SS LEAD STYLE				H1	H2	FULLY MATED	MIN @ H MAX
		-01, -03							
		FULLY MATED	MAX						
3601-PS LEAD STYLE	-01	6.02	6.48	5.59	4.57	0.84	0.38		
	-03	6.02	6.48	5.59	4.57	0.84	0.38		
	-11	7.80	8.26	7.37	4.57	0.84	0.38		
	-13	7.80	8.26	7.37	4.57	0.84	0.38		
	-21	9.58	10.04	9.14	4.57	0.84	0.38		
	-23	9.58	10.04	9.14	4.57	0.84	0.38		
	-31	11.48	11.94	11.05	4.57	0.84	0.38		

TABLE 7:

		ASS'Y HIGH(H)		MALE	FEMALE	WIPE			
		3601-SS LEAD STYLE				H1	H2	FULLY MATED	MIN @ H MAX
		-01, -03							
		FULLY MATED	MAX						
3601-PM LEAD STYLE	-02	6.17	6.63	5.74	4.57	0.84	0.38		
	-12	7.95	8.41	7.52	4.57	0.84	0.38		
	-22	9.73	10.19	9.30	4.57	0.84	0.38		
	-32	11.63	12.09	11.20	4.57	0.84	0.38		

TABLE 8:

		ASS'Y HIGH(H)		MALE	FEMALE	WIPE			
		3601-SS LEAD STYLE				H1	H2	FULLY MATED	MIN @ H MAX
		-01, -03							
		FULLY MATED	MAX						
3601-PR LEAD STYLE	-01-RA	6.02	6.48	5.59	4.57	0.84	0.38		
	-01-RE1	6.10	6.56	6.10	4.57	0.84	0.38		
	-01-RE2	6.10	6.56	6.10	4.57	0.84	0.38		

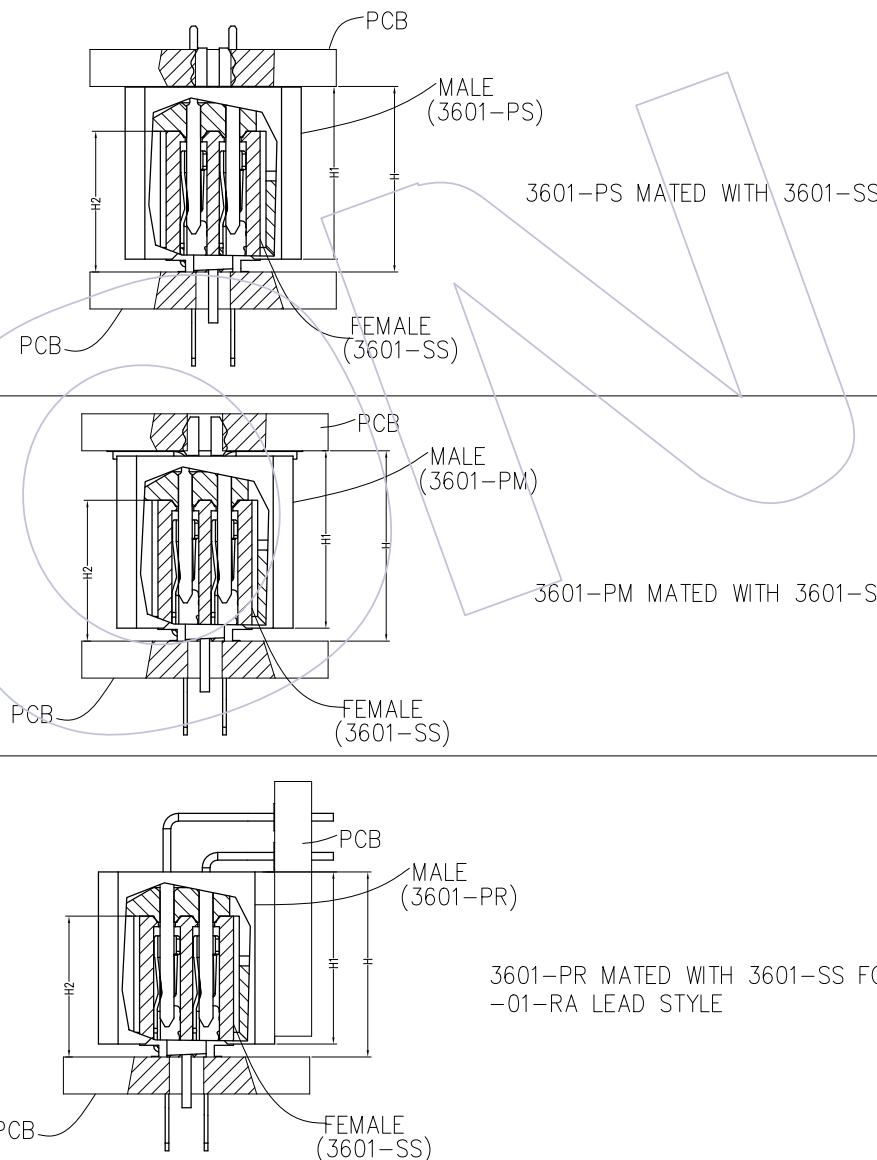



				OPERATION	DRAW	DATE	SCALE	FIT	PART NO.
				x.x	Ken	2021/10/20	UNIT	mm	3601-SXXX-CX1SXXXX
				x.xx	CHECK	DATE	SIZE	A4	TITLE:
AO	2021/10/20	NEW	Ken	x.xxx	APPROVE	DATE	SHEET	6/7	1.27mm BTB Female Header
REV	DATE	MODIFICATION DESCRIPTION	CHANGE	Angle			PROJ.		W=3.05, -LC STYLE, DIP
				DIM	TOL				Customer NO.

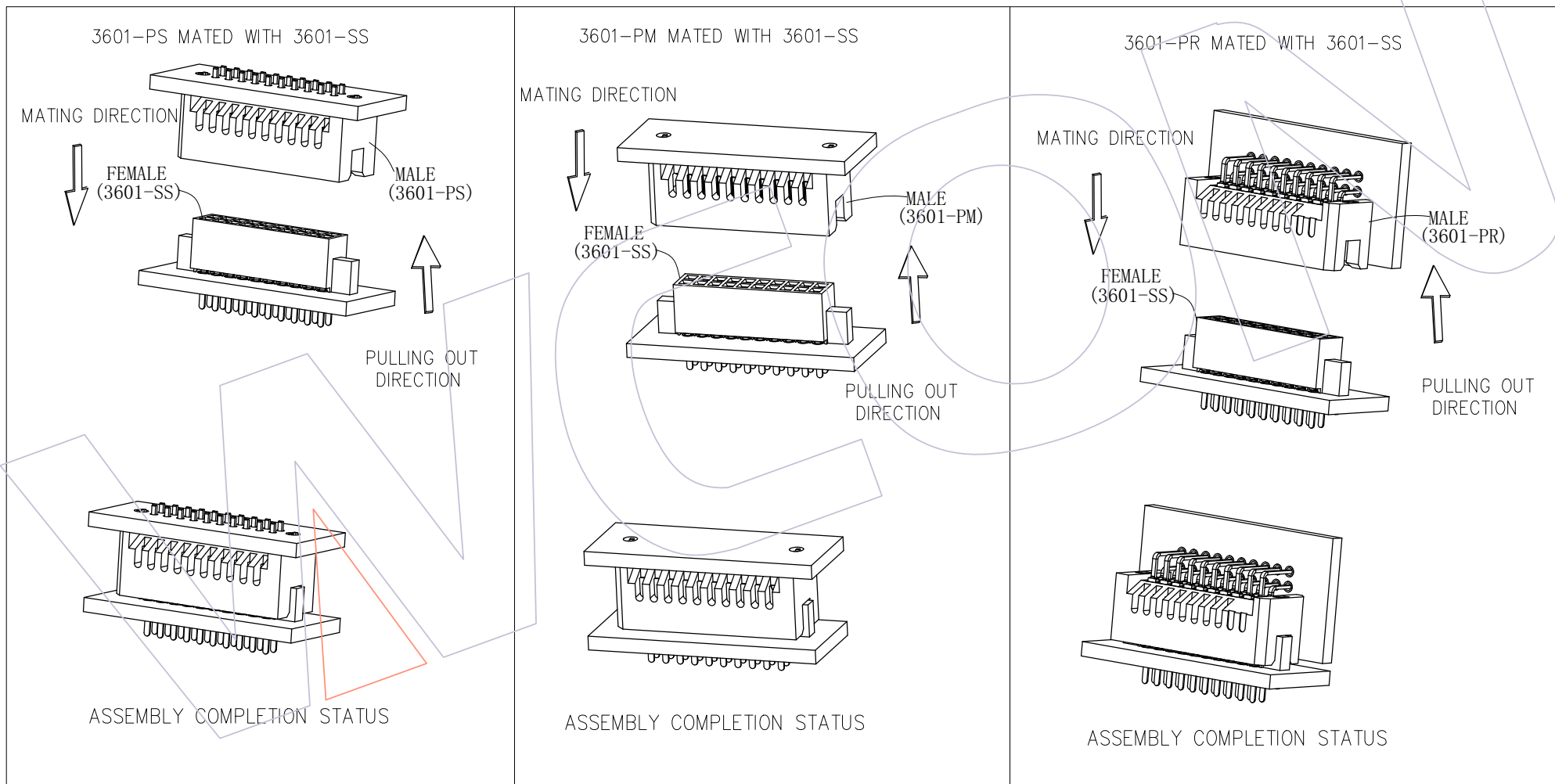

Http: www.wcon.com

WCON-Dongguan Tel: +86 769 85358920 Fax: +86 769 85358915 E-mail: sales@wcon.com	WCON-Kunshan Tel: +86 512 57468408 Fax: +86 512 57468468 E-mail: salesks@wcon.com
---	--



				OPERATION	DRAW	DATE	SCALE	FIT	PART NO.	 Http: www.wcon.com
				x.x ±0.40	Ken	2021/10/20	UNIT	mm	3601-SXXX-CX1SXXXXX	
				x.xx ±0.25	CHECK	DATE	SIZE	A4	TITLE:	
				x.xxx ±0.15	APPROVE	DATE	SHEET	7/7	1.27mm BTB Female Header W=3.05, -LC STYLE, DIP	
AO	2021/10/20	NEW	Ken	Angle ± 3'			PROJ.	Customer NO.		WCON-Dongguan Tel: +86 769 85358920 Fax: +86 769 85358915 E-mail: sales@wcon.com
REV	DATE	MODIFICATION DESCRIPTION	CHANGE	DIM TOL						WCON-Kunshan Tel: +86 512 57468408 Fax: +86 512 57468468 E-mail: salesks@wcon.com