

HSF

NOTES:

- 1.Current Rating:2A Max (only one pin) ;
- 2.Voltage Rating:225V DC;
- 3.Contact Resistance:30mΩ Max;
- 4.Withstand Voltage:750V AC;
- 5.Insulation Resistance:5000MΩ Min;
- 6.Operating Temperature: -55°C to +125°C;
- 7.Insulator Material: LCP,G.F,UL94V-0,BK;
- 8.Contact Material:Copper Alloy;
- 9.Contact plating:
Au on contact area (See ordering information),
100μ" Matte TIN on solder area,
50μ" Nickel underplating overall;
- 10.Recommended process:
Reflow,Peak temperature:260±5°C, 10s ;

Ordering Information

37 5 1 X- P M XX0 OXX XX X XX

OPTIONS J

- 1=A
- 2=LC
- 3=FL
- P=PLUG
- M=180° SMT

No OF POSITIONS

- 040=40PIN
- 080=80PIN
- 120=120PIN
- 160=160PIN
- 200=200PIN

LEAD STYLE

- 042=4.26
- 072=7.26

WCON INTERNAL CODE

PACKAGING

- A=VACUUM BOX
- R=TAPE&REEL

PLATING

- W1=SEL.3U"GOLD/MATTE SN
- W3=SEL.10U"GOLD/MATTE SN
- W5=SEL.30U"GOLD/MATTE SN

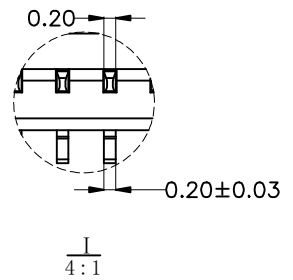
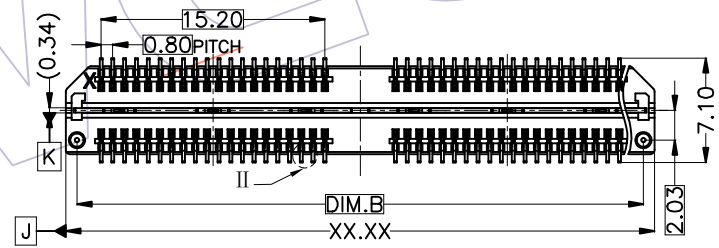
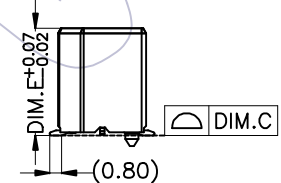
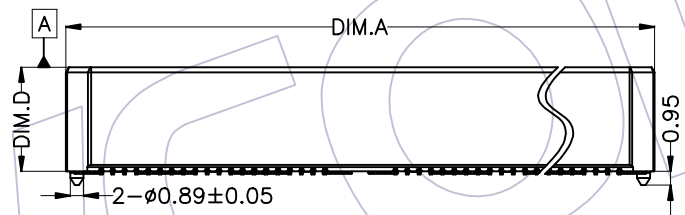
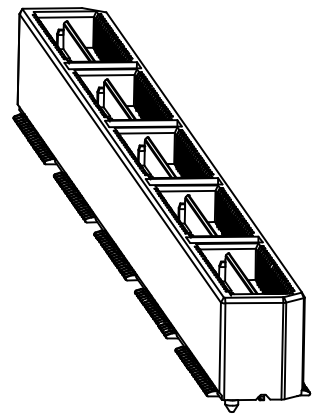
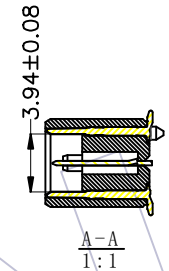
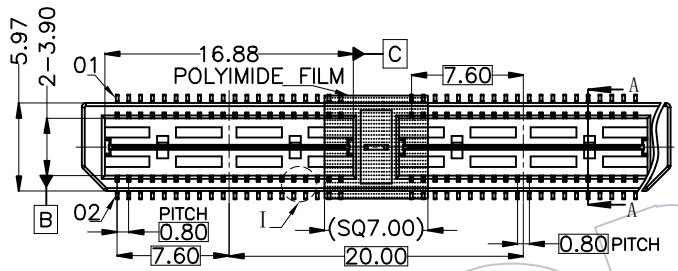

REV	DATE	MODIFICATION DESCRIPTION	CHANGE	OPERATION	DRAW	DATE	SCALE	Fit	PART NO. 3751X-PMXX0-OXXXXX01
				x.x ±0.40	Abt Chen	2022.07.20	UNIT	mm	
				x.xx ±0.25	CHECK	DATE	SIZE	A4	
				x.xxx ±0.15	APPROVE	DATE	SHEET	1/4	
				Angle ± 3°			PROJ.	Customer NO.	
				DIM TOL					

WCON

Http: www.wcon.com

WCON-Dongguan
Tel: +86 769 85358920
Fax: +86 769 85358915
E-mail: sales@wcon.com

WCON-Kunshan
Tel: +86 512 57468408
Fax: +86 512 57468468
E-mail: salesks@wcon.com

HSF

SPECIFICATION&SIZE LIST

OPTIONS	P/N	PIN	DIM.A	DIM.B	DIM.C	DIM.D	DIM.E	DIM.F
-A (CONVENTION)	37511-PM040-042XXX01	2*20	20.00 ^{+0.02} _{-0.06}	18.48	0.10	4.06	4.26	
	37511-PM080-042XXX01	2*40	40.00 ^{+0.02} _{-0.06}	38.48	0.10	4.06	4.26	
	37511-PM120-042XXX01	2*60	60.00 ^{+0.02} _{-0.06}	58.48	0.15	4.06	4.26	
	37511-PM160-042XXX01	2*80	80.00 ^{+0.02} _{-0.06}	78.48	0.15	4.06	4.26	
	37511-PM200-042XXX01	2*100	100.00 ^{+0.02} _{-0.06}	98.48	0.15	4.06	4.26	
	37511-PM040-072XXX01	2*20	20.00 ^{+0.02} _{-0.06}	18.48	0.10	7.06	7.26	
	37511-PM080-072XXX01	2*40	40.00 ^{+0.02} _{-0.06}	38.48	0.10	7.06	7.26	
	37511-PM120-072XXX01	2*60	60.00 ^{+0.02} _{-0.06}	58.48	0.15	7.06	7.26	
	37511-PM160-072XXX01	2*80	80.00 ^{+0.02} _{-0.06}	78.48	0.15	7.06	7.26	
	37511-PM200-072XXX01	2*100	100.00 ^{+0.02} _{-0.06}	98.48	0.15	7.06	7.26	
-LC (LOCKING CLIPS)	37512-PM040-042XXX01	2*20	20.00 ^{+0.02} _{-0.06}	18.48	0.10	4.06	4.26	
	37512-PM080-042XXX01	2*40	40.00 ^{+0.02} _{-0.06}	38.48	0.10	4.06	4.26	
	37512-PM120-042XXX01	2*60	60.00 ^{+0.02} _{-0.06}	58.48	0.15	4.06	4.26	
	37512-PM160-042XXX01	2*80	80.00 ^{+0.02} _{-0.06}	78.48	0.15	4.06	4.26	
	37512-PM200-042XXX01	2*100	100.00 ^{+0.02} _{-0.06}	98.48	0.15	4.06	4.26	
	37512-PM040-072XXX01	2*20	20.00 ^{+0.02} _{-0.06}	18.48	0.10	7.06	7.26	
	37512-PM080-072XXX01	2*40	40.00 ^{+0.02} _{-0.06}	38.48	0.10	7.06	7.26	
	37512-PM120-072XXX01	2*60	60.00 ^{+0.02} _{-0.06}	58.48	0.15	7.06	7.26	
	37512-PM160-072XXX01	2*80	80.00 ^{+0.02} _{-0.06}	78.48	0.15	7.06	7.26	
	37512-PM200-072XXX01	2*100	100.00 ^{+0.02} _{-0.06}	98.48	0.15	7.06	7.26	
-FL (FRICTION LOCKS)	37513-PM040-042XXX01	2*20	20.00 ^{+0.02} _{-0.06}	18.48	0.10	4.06	4.26	20.50
	37513-PM080-042XXX01	2*40	40.00 ^{+0.02} _{-0.06}	38.48	0.10	4.06	4.26	40.50
	37513-PM120-042XXX01	2*60	60.00 ^{+0.02} _{-0.06}	58.48	0.15	4.06	4.26	60.50
	37513-PM160-042XXX01	2*80	80.00 ^{+0.02} _{-0.06}	78.48	0.15	4.06	4.26	80.50
	37513-PM200-042XXX01	2*100	100.00 ^{+0.02} _{-0.06}	98.48	0.15	4.06	4.26	100.50
	37513-PM040-072XXX01	2*20	20.00 ^{+0.02} _{-0.06}	18.48	0.10	7.06	7.26	20.50
	37513-PM080-072XXX01	2*40	40.00 ^{+0.02} _{-0.06}	38.48	0.10	7.06	7.26	40.50
	37513-PM120-072XXX01	2*60	60.00 ^{+0.02} _{-0.06}	58.48	0.15	7.06	7.26	60.50
	37513-PM160-072XXX01	2*80	80.00 ^{+0.02} _{-0.06}	78.48	0.15	7.06	7.26	80.50
	37513-PM200-072XXX01	2*100	100.00 ^{+0.02} _{-0.06}	98.48	0.15	7.06	7.26	100.50

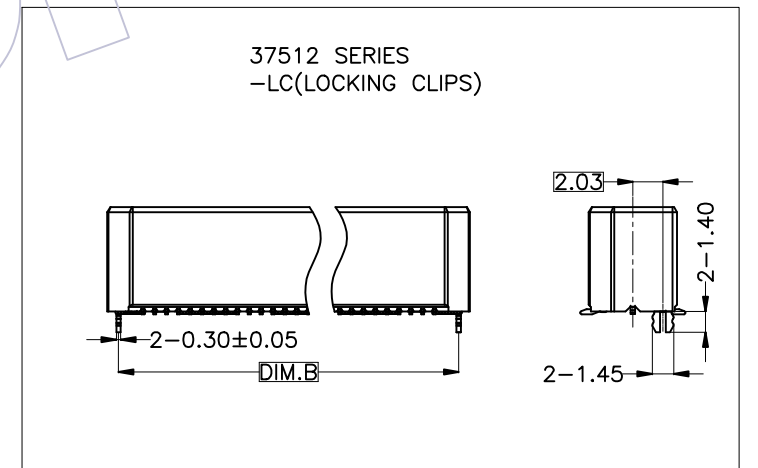
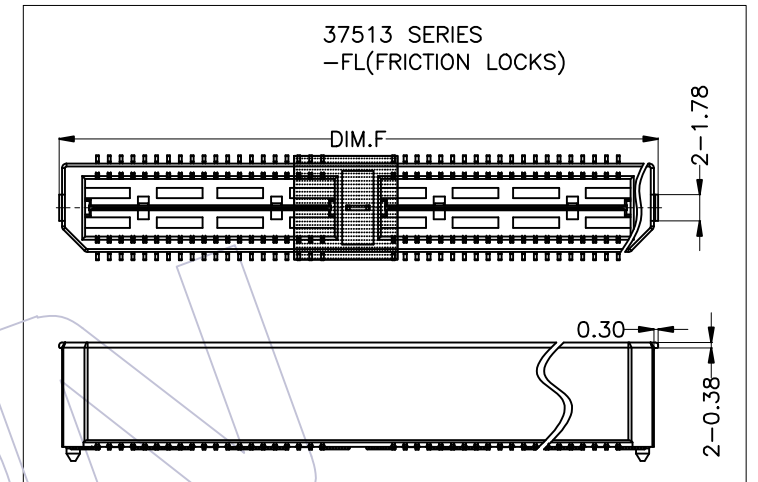

				OPERATION	DRAW	DATE	SCALE	Fit	PART NO.	 Http: www.wcon.com	
				x.x ±0.40	Abt Chen	2022.07.20	UNIT	mm	3751X-PMXX0-0XXXXX01		
				x.xx ±0.25	CHECK	DATE	SIZE	A4	TITLE:		
				x.xxx ±0.15	APPROVE	DATE	SHEET	2/4	0.8mmB0 TO B0 PLUG SMT, ASSEMBLY		
AO	2022.07.20	NEW		Angle ± 3°			PROJ.	⊕	Customer NO.		
REV	DATE	MODIFICATION DESCRIPTION	CHANGE	DIM TOL						WCON-Dongguan Tel: +86 769 85358920 Fax: +86 769 85358915 E-mail: sales@wcon.com	WCON-Kunshan Tel: +86 512 57468408 Fax: +86 512 57468468 E-mail: salesks@wcon.com

HSF

MATED HEIGHT

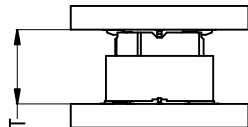

MATED HEIGHT	SOCKET HEIGHT	MALE HEIGHT	DEVELOPMENT STATUS
5.00	3.25	4.26	YES
8.00	3.25	7.26	YES

LENGTH SPECIFICATION DISPLAY

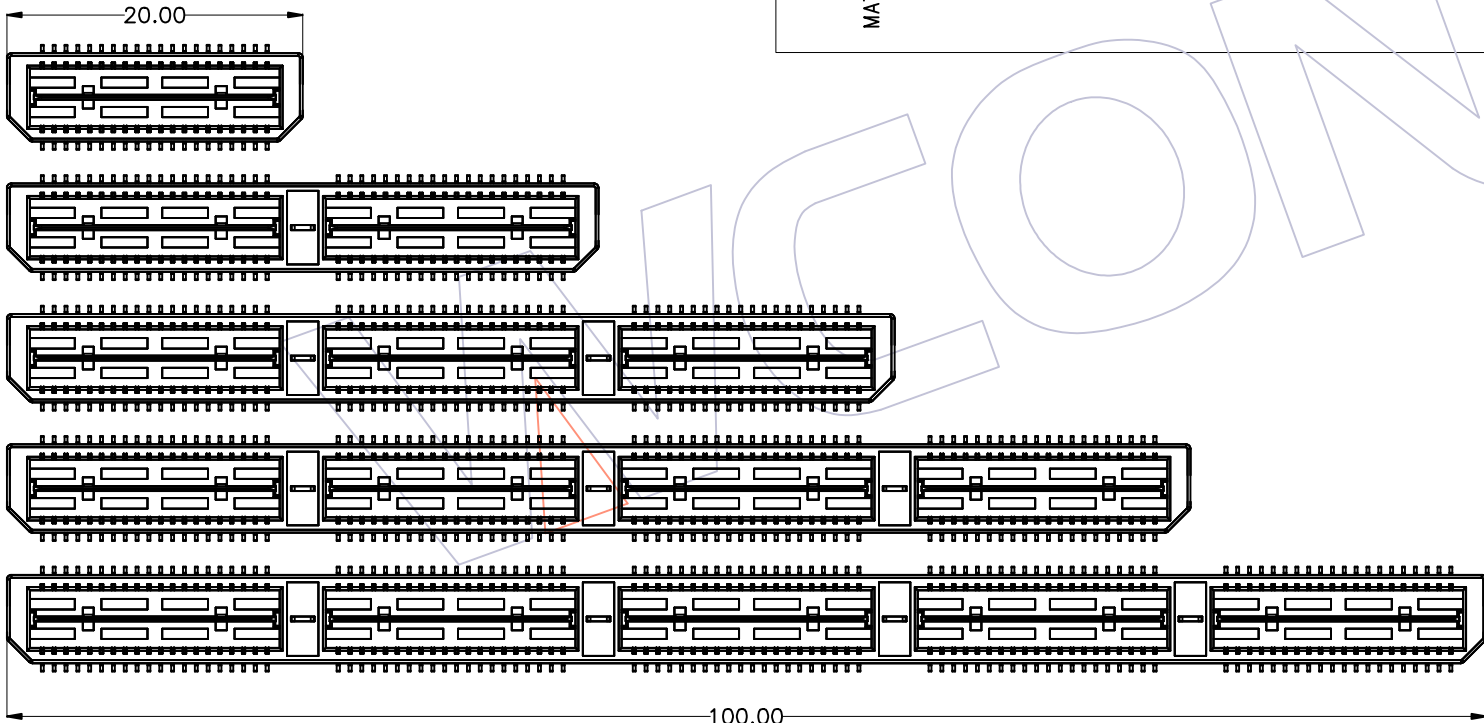

REV	DATE	MODIFICATION DESCRIPTION	CHANGE	OPERATION	DRAW	DATE	SCALE	Fit	PART NO.
A0	2022.07.20	NEW	—	x.x ±0.40	Abt Chen	2022.07.20	UNIT	mm	3751X-PMXX0-0XXXXX01
				x.xx ±0.25	CHECK	DATE	SIZE	A4	TITLE:
				x.xxx ±0.15	APPROVE	DATE	SHEET	3/4	0.8mmB0 TO B0 PLUG SMT, ASSEMBLY
				Angle ± 3'			PROJ.	⊕	Customer NO.
				DIM TOL					



Http: www.wcon.com

WCON-Dongguan Tel: +86 769 85358920 Fax: +86 769 85358915 E-mail: sales@wcon.com	WCON-Kunshan Tel: +86 512 57468408 Fax: +86 512 57468468 E-mail: salesks@wcon.com
---	--

HSF

RECOMMENDED PCB LAYOUT (COMPONENT SIDE)
TOLERANCE ±0.05

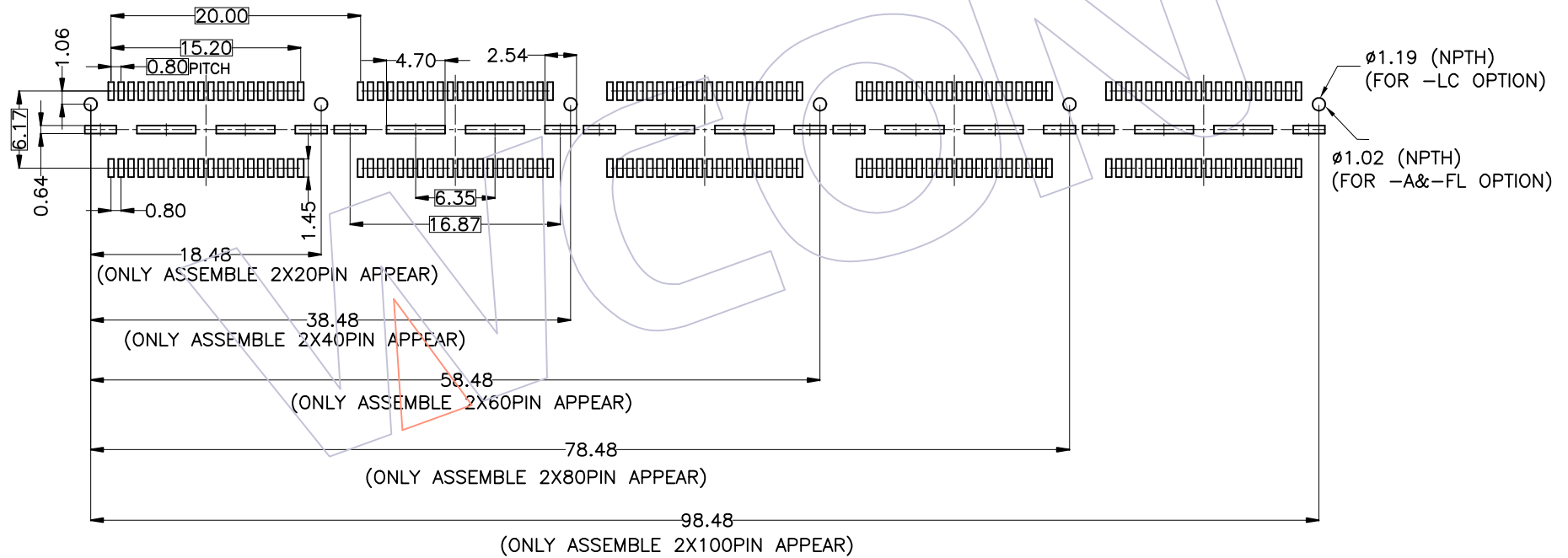

				OPERATION	DRAW	DATE	SCALE	Fit	PART NO.
				x.x ±0.40	Abt Chen	2022.07.20	UNIT	mm	3751X-PMXX0-0XXXXX01
				x.xx ±0.25	CHECK	DATE	SIZE	A4	TITLE:
				x.xxx ±0.15	APPROVE	DATE	SHEET	4/4	0.8mmB0 TO B0 PLUG SMT, ASSEMBLY
AO	2022.07.20	NEW	—	Angle ± 3°			PROJ.	⊕	Customer NO.
REV	DATE	MODIFICATION DESCRIPTION	CHANGE	DIM TOL					

WCON
Http: www.wcon.com

WCON-Dongguan Tel: +86 769 85358920 Fax: +86 769 85358915 E-mail: sales@wcon.com	WCON-Kunshan Tel: +86 512 57468408 Fax: +86 512 57468468 E-mail: salesks@wcon.com
---	--