

## WF2549 Series

2.54mm pitch/Wire-to-board Connector

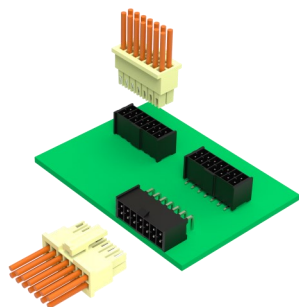

### Overview

The 2.54mm pitch WF2549 is a discrete wire-to-board solution that meets a wide range of design requirements, with a current rating of up to 3A for reliable operation in harsh environments, and provides horizontal and vertical mounting at the end of the board to meet the customer's different angles of docking adaptations.

### Features and Benefits

- Locking structure to prevent accidental dislodgement
- Anti-misplug structure, effectively avoiding misinsertion
- Straight and curved plugs available
- Wiring range 22-24AWG

### Product Applications

- Industrial equipment: automation equipment, artificial robots, measurement/control equipment
- Computers: TV equipment, heating equipment, communication equipment
- Lighting equipment: LED lamps, lighting systems

### Standard 标准

- EIA 364

### Material 材料

Part/零件	Material/材料	Finish/电镀	UL Flame retardant/阻燃等级
Housing/主体	PA66	White/白色 Black/黑色	UL94V-0
Header/板端	LCP	White/白色 Black/黑色 Beige/米黄色	UL94V-0
Terminal/端子	phosphor bronze 磷铜 (C5191)	Au or Sn plated 镀金或锡	-

## WF2549系列

2.54mm间距/线到板连接器



Two-point contact  
双点接触

### 概述

2.54mm间距WF2549是一款带有分立式线到板解决方案，可满足各种设计需求，额定电流高达3A，可在恶劣环境中可靠工作，板端提供水平及垂直方向安装，满足客户不同角度对插适配。

### 产品特点

- 锁扣结构，防止意外脱落
- 防错插设计、有效避免错插
- 提供直插、弯插供选择
- 接线范围 22-24AWG

### 应用领域

- 工业设备：自动化设备、人工机器人、测量/控制设备
- 家用电器：电视机设备、供暖设备、通讯设备
- 照明设备：LED灯具、照明系统

Production Specifications 产品规格

Current rating 额定电流	3.0 A	Operating Temperature Range:-40° C~+105° (including temperature rise) Operating Humidity Range:20-80% 工作温度范围: -55° C~+125° C(含温升) 工作湿度范围: ≤80%	Storage Teroerature: Operating Humidity: 储存温度: 25±5° C 储存湿度: ≤60%
Voltage rating 额定电压	250V		

Item 项目	Condition 条件	Specification 规格
Insulation Resistance 绝缘电阻	Measured at 1000V DC for 1 minute 测试电压: 1000V DC/1分钟	No less than 1000M Ω 不少于1000MΩ
Withstanding voltage 耐电压	Measured at 1000V AC for 1 minute 测试电压: 1000V AC/1分钟	No breakdown, no discharge, leakage current <0.5mA 无击穿、无放电、漏电流<0.5mA
Contact Resistance 接触电阻	Measured at 100mA and no higher than 20mV 用20 mV DC进行测量	Contact resistance: Initial value/ 20 mo max After environmental tests/ 30 mo max. 接触电阻: 初始值 20 mΩ 以下 测试后 30 mΩ 以下
Vibration Resistance 抗振动	Frequency : 50 ~ 2000 Hz PSD value: 5.35 Gms minimum Vibration Direction : X,Y,Z Duration : 8 h each 频率: 50 ~ 2000 Hz PSD: 5.35 Gms 振动方向: X,Y,Z 振动时间: 各8小时	No electrical discontinuity of 1μs or greater 试验过程中未发生1μs瞬断现象, 且外观无损伤, 电气性能正常
Humidity (Steady state) 湿度	Temperature : 25~65°C Humidity: 90 ~95% (R.H) Duration : 96 hours 温度: 25~65° C 湿度: 90 ~95% (R.H) 时间: 96小时	Contact resistance: Initial value/ 20 mo max After environmental tests/ 30 mo max. 接触电阻: 初始值 20 mΩ 以下 测试后 30 mΩ 以下
Salt Spray 盐雾	Temperature:35#2°C Humidity:95~98%(R.H) PHValue : 6.5 ~ 7.2 Duration : 48hours (Gold Area) 温度: 35±2° C 湿度: 95~98%(R.H) PH值: 6.5~7.2 时间: 24小时	Contact resistance: Initial value/ 20 mo max After environmental tests/ 30 mo max. 接触电阻: 初始值 20 mΩ 以下 测试后 30 mΩ 以下
Durability(Mating/un- mating) 插拔寿命	500 cycles 循环500次	Contact resistance: Initial value/ 20 mo max After environmental tests/ 30 mo max. 接触电阻: 初始值 20 mΩ 以下 测试后 30 mΩ 以下

PCB Layout 印刷电路板布局

Through-hole type 通孔型

(S/T DIP、R/A DIP)

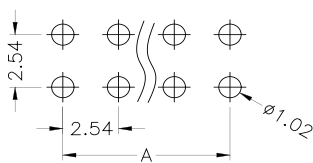

SMT type 表面贴装型

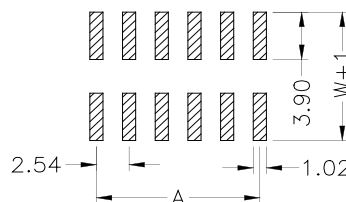

# WF2549 Series

## Ordering Information 订购信息

Circuit 芯数	Part number 型号		Dimensions 尺寸 (mm)		Parkage 包装 Q'ty/Tube 只/管装		Remake 可量产状态	
	S/T DIP	R/A DIP	A	B	S/T DIP	R/A DIP	S/T DIP	R/A DIP
2	WF2549-2WS02XXXT1	WF2549-2WR02XXXTX	2.54	6.60	87	87	*	*
3	WF2549-2WS03XXXT1	WF2549-2WR03XXXTX	5.08	9.14	63	63	*	*
4	WF2549-2WS04XXXT1	WF2549-2WR04XXXTX	7.62	11.68	49	49	*	*
5	WF2549-2WS05XXXT1	WF2549-2WR05XXXTX	10.16	14.22	40	40	*	*
6	WF2549-2WS06XXXT1	WF2549-2WR06XXXTX	12.70	16.76	34	34	*	*
7	WF2549-2WS07XXXT1	WF2549-2WR07XXXTX	15.24	19.30	30	30	*	*
8	WF2549-2WS08XXXT1	WF2549-2WR08XXXTX	17.78	21.84	26	26	*	*
9	WF2549-2WS09XXXT1	WF2549-2WR09XXXTX	20.32	24.38	23	23	*	*
10	WF2549-2WS10XXXT1	WF2549-2WR10XXXTX	22.86	26.92	21	21	*	*
11	WF2549-2WS11XXXT1	WF2549-2WR11XXXTX	25.40	29.46	19	19	*	*
12	WF2549-2WS12XXXT1	WF2549-2WR12XXXTX	27.94	32.00	18	18	*	*
13	WF2549-2WS13XXXT1	WF2549-2WR13XXXTX	30.48	34.54	16	16	*	*
14	WF2549-2WS14XXXT1	WF2549-2WR14XXXTX	33.02	37.08	15	15	*	*
15	WF2549-2WS15XXXT1	WF2549-2WR15XXXTX	35.56	39.62	14	14	*	*
16	WF2549-2WS16XXXT1	WF2549-2WR16XXXTX	38.10	42.16	13	13	*	*
17	WF2549-2WS17XXXT1	WF2549-2WR17XXXTX	40.64	44.70	12	12	*	*
18	WF2549-2WS18XXXT1	WF2549-2WR18XXXTX	43.18	47.24	12	12	*	*
19	WF2549-2WS19XXXT1	WF2549-2WR19XXXTX	45.72	49.78	11	11		
20	WF2549-2WS20XXXT1	WF2549-2WR20XXXTX	48.26	52.32	11	11	*	*
21	WF2549-2WS21XXXT1	WF2549-2WR21XXXTX	50.80	54.86	10	10		
22	WF2549-2WS22XXXT1	WF2549-2WR22XXXTX	53.34	57.40	10	10		
23	WF2549-2WS23XXXT1	WF2549-2WR23XXXTX	55.88	59.94	9	9	*	*
24	WF2549-2WS24XXXT1	WF2549-2WR24XXXTX	58.42	62.48	9	9		
25	WF2549-2WS25XXXT1	WF2549-2WR25XXXTX	60.96	65.02	8	8	*	*

Note: \* stands for mass production . 注: \*代表可量产

### Dimensions 尺寸 (S/T DIP)

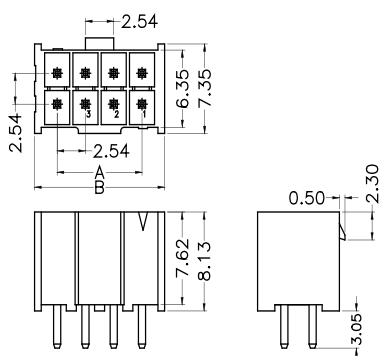

### Dimensions 尺寸 (R/A DIP)

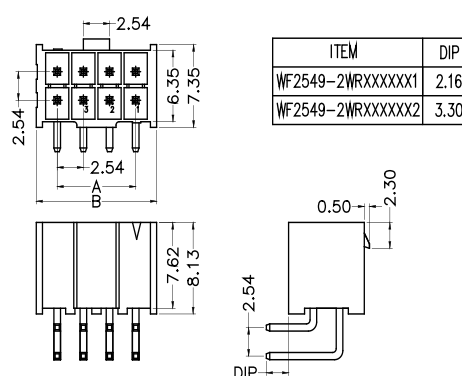

### Assembly Schematic 装配示意

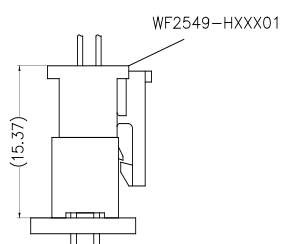

### Assembly Schematic 装配示意

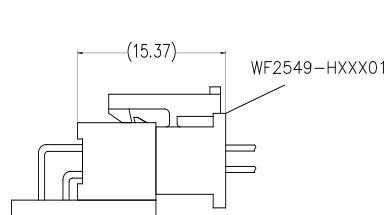

Dimensions 尺寸

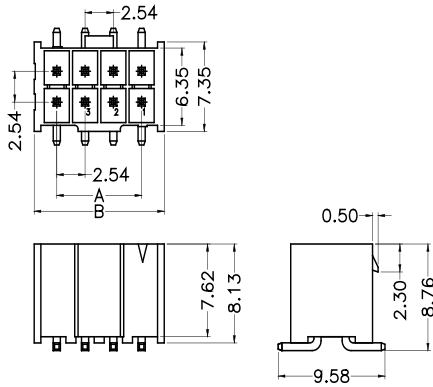

Assembly Schematic 装配示意

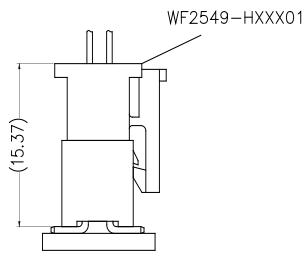

Ordering Information 订购信息

Circuit 芯数	Part number 型号	Dimensions 尺寸 (mm)		Package 包装 Q'ty/Tube 只/管装	Remake 可量产状态
		A	B		
2	WF2549-2WM02XXX1	2.54	6.60	87	*
3	WF2549-2WM03XXX1	5.08	9.14	63	*
4	WF2549-2WM04XXX1	7.62	11.68	49	*
5	WF2549-2WM05XXX1	10.16	14.22	40	*
6	WF2549-2WM06XXX1	12.70	16.76	34	*
7	WF2549-2WM07XXX1	15.24	19.30	30	*
8	WF2549-2WM08XXX1	17.78	21.84	26	*
9	WF2549-2WM09XXX1	20.32	24.38	23	*
10	WF2549-2WM10XXX1	22.86	26.92	21	*
11	WF2549-2WM11XXX1	25.40	29.46	19	*
12	WF2549-2WM12XXX1	27.94	32.00	18	*
13	WF2549-2WM13XXX1	30.48	34.54	16	*
14	WF2549-2WM14XXX1	33.02	37.08	15	*
15	WF2549-2WM15XXX1	35.56	39.62	14	*
16	WF2549-2WM16XXX1	38.10	42.16	13	*
17	WF2549-2WM17XXX1	40.64	44.70	12	*
18	WF2549-2WM18XXX1	43.18	47.24	12	*
19	WF2549-2WM19XXX1	45.72	49.78	11	
20	WF2549-2WM20XXX1	48.26	52.32	11	*
21	WF2549-2WM21XXX1	50.80	54.86	10	
22	WF2549-2WM22XXX1	53.34	57.40	10	
23	WF2549-2WM23XXX1	55.88	59.94	9	*
24	WF2549-2WM24XXX1	58.42	62.48	9	
25	WF2549-2WM25XXX1	60.96	65.02	8	*

## Dimen-

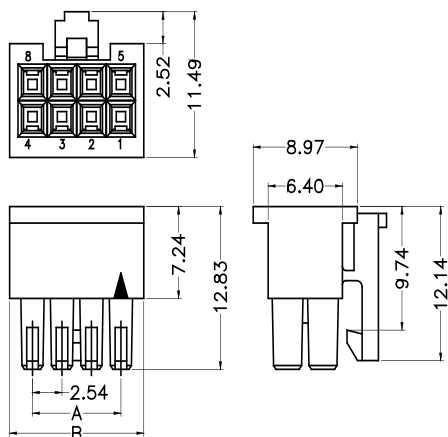

## Adaptor Terminal 适配端子 (WF2549-TPXX02)

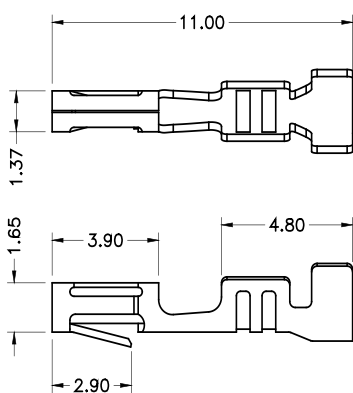

## Ordering Information 订购信息

Circuit 芯数	Part number 型号	Dimensions		Package 包装 Q'ty/Bag 只/袋装	Remake 可量产状态
		A	B		
2	WF2549-2H02X01	2.54	8.26	1000	*
3	WF2549-2H03X01	5.08	9.02	1000	*
4	WF2549-2H04X01	7.62	11.56	1000	*
5	WF2549-2H05X01	10.16	14.10	800	*
6	WF2549-2H06X01	12.70	16.64	700	*
7	WF2549-2H07X01	15.24	19.18	600	*
8	WF2549-2H08X01	17.78	21.72	500	*
9	WF2549-2H09X01	20.32	24.26	400	*
10	WF2549-2H10X01	22.86	26.80	400	*
11	WF2549-2H11X01	25.40	29.34	400	*
12	WF2549-2H12X01	27.94	31.88	350	*
13	WF2549-2H13X01	30.48	34.42	350	
14	WF2549-2H14X01	33.02	36.96	350	
15	WF2549-2H15X01	35.56	39.50	300	*
16	WF2549-2H16X01	38.10	42.04	250	*
17	WF2549-2H17X01	40.64	44.58	250	
18	WF2549-2H18X01	43.18	47.12	250	*
19	WF2549-2H19X01	45.72	49.66	250	
20	WF2549-2H20X01	48.26	52.20	150	*
21	WF2549-2H21X01	50.80	54.74	150	
22	WF2549-2H22X01	53.34	57.28	150	
23	WF2549-2H23X01	55.88	59.82	150	
24	WF2549-2H24X01	58.42	62.36	150	
25	WF2549-2H25X01	60.96	64.90	150	*

## Terminal Crimp specification 端子压接规范

型号 Model number	电线类型 Wire type	电线规格 Wire size	线缆 OD (mm) Cable OD (mm)	剥线长度 (mm) Strip length (mm)	导体铆压 (A-A) Conductor crimp		绝缘体铆压 (B-B) Insulation crimp	
					压接宽度CW1(mm) Crimping width(mm)	压接高度 (mm) Crimping height(mm)	压接宽度CW2(mm) Crimping width (mm)	压接高度CH2(mm) Crimping width(mm)
WF2549-TPXX02	UL 1061	22 AWG	1.3±0.10	3.80±0.50	1.45±0.03	1.00±0.03	1.70 Ref.	1.60 Ref.
	UL 1007	24 AWG	1.4±0.10		1.45±0.03	0.90±0.03	1.70 Ref.	1.70 Ref.

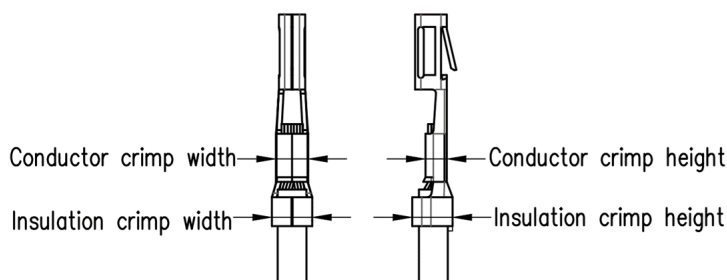

Model number allocation 型号命名

<b>WF2549</b>	-	<b>2</b>	<b>XX</b>	<b>XX</b>	<b>XX</b>	<b>X</b>	<b>X</b>	<b>X</b>
(1)		(2)	(3)	(4)	(5)	(6)	(7)	(8)
(1) Series (系列): Wafer 2.54mm Series					(5) plating (电镀): Blank=Tin、S0=Gold Flash/Tin、S3=10u"Gold/Tin、S4=15u"Gold/Tin、S5=30u"Gold/Tin			
(2) Row (排数): 2=Dual Row					(6) Color(颜色): W=White、B=Black、E=Natural			
(3) Terminal type(端子形态): WS=S/T DIP WR=R/A DIP WZ=R/A SMT					(7) Packing(包装): 0=PE Bag、T=Tuble			
(4) Circuit(位数): 02=2.....25=25P					(8) Internal code(流水码)			

<b>WF2549</b>	-	<b>2</b>	<b>H</b>	<b>XX</b>	<b>B</b>	<b>0</b>	<b>1</b>
(1)		(2)	(3)	(4)	(5)	(6)	(7)
(1) Series (系列): Wafer 2.50mm Series					(5) Color(颜色): B=Black、W=White		
(2) Row (排数): 2=Dual Row					(6) Packing(包装): 0=PE Bag		
(3) Product type(产品类型): H=Crimp Type Housing					(7) Internal code(流水码)		
(4) Circuit(位数): 02=2.....25=25P							

Contact Us 联系我们

维峰电子股份有限公司(总部)  
WCON ELECTRONICS CO.,LTD(HQ)  
地址:广东省东莞市虎门镇大宁文明路15号  
Add :No.15,Wenming Road,Daning Community, Humen Town, Dongguan, Guangdong.523930, China

昆山维康电子有限公司  
KUNSHAN WCON ELECTRONICIS CO.,LTD(East of China)  
地址:江苏昆山千灯镇石浦新虹路321号  
Add : No.321, Xinhong Road, Shipu, QiandengTown, Kunshan, Jiangsu, China

合肥维峰电子有限公司  
HEFEI WCON ELECTRONICIS CO.,LTD  
地址:安徽合肥市高新技术开发区绿城科技园E栋2楼  
Add : 2F, Building E, Greentown Science Park,High-tech Development Zone, Hefei, Anhui,China

维康电子(泰国)有限公司  
WCON ELECTRONICS (Thailand) CO.,LTD  
地址:泰国巴真武里府西玛铺县华瓦区洛加纳工业园  
Add: VG3C+H57, Hua Wa, Si Maha Phot District, Prachin Buri 25140, Thailand

销售联系方式 Sales Contacts

国际客户部 International Sales Department  
salesdg01@wcon.com  
salesdg05@wcon.com

大客户专线 Key Account Line  
华南: salesdg28@wcon.com  
华东: salesks@wcon.com

中小客户专线 Small and Medium-sized Account Line  
华南: salesdg10@wcon.com  
华东: salesks01@wcon.com

网络销售 Online sales  
salesdg26@wcon.com



Official Website



Product e-catalog



WeChat Public#



TikTok Public#