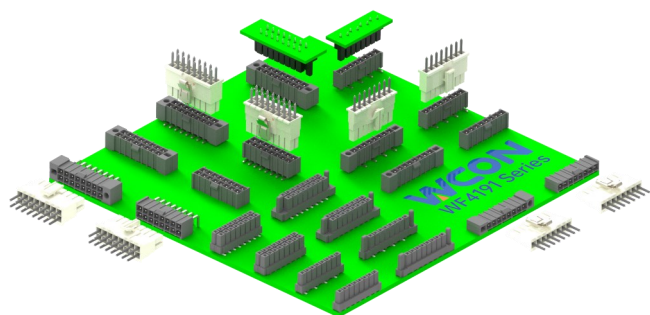

WF4191 Series

4.19mm pitch/Wire-to-board, board-to-board connector

WF4191 系列

4.19mm间距/线到板、板到板连接器

Two-contact
两点接触

Overview

WF4191 is a 4.19mm pitch wire-to-board and wire-to-wire connector featuring versatile product configurations and flexible adaptability. Its snap-fit design ensures stable and complete signal transmission. The board-side connector supports both horizontal and vertical mounting, accommodating customer requirements for mating at various angles.

Features and Benefits

- Anti-misplug structure
- Snap-fit design ensures secure and reliable attachment, preventing separation or detachment.
- Versatile mounting options accommodate diverse customer application scenarios.
- Features anti-misalignment guide pins to guarantee precise positioning during assembly.
- Available in single-row or double-row configurations.

Product Applications

- Industrial: Automation equipment, industrial servers
- Consumer: HVAC systems, refrigerators, washing machines
- Networking: Routers, servers, storage devices
- Medical: Diagnostic equipment, patient monitors

Standard 标准

- GB/T5095

Material 材料

Part/零件	Material/材料	Finish/电镀	UL Flame retardant/阻燃等级
Housing/主体	PA66	White/白色	UL94V-0
Header/板端	LCP	Black/黑色	UL94V-0
Terminal/端子	Copper Alloy/铜合金	Tin-plated/镀锡	-

概述

WF4191是一款4.19mm间距线到板、线到线连接器，产品形态多样，适配灵活，且带有卡扣设计能有效确保信号传输的稳定性以及完整性，板端提供水平及垂直方向安装，满足客户不同角度对插适配。

产品特点

- 防呆设计
- 卡扣设计，适配牢固可靠，避免分离脱落
- 适配方式多样化，可满足客户各种场合的应用需求
- 带有防呆导向柱设计，确保正确位置对配
- 单排、双排可选

应用领域

- 工业：自动化设备、工业服务器
- 消费类：暖通空调、冰箱、洗衣机
- 网络：路由器、服务器、存储器
- 医疗：诊断设备、病人监护仪

Production Specifications 产品规格

Current rating 额定电流	11 A	Operating temperature Range:-40° C~+105° C (including temperature rise) Operating Humidity Range:20-80% 工作温度范围: -40° C~+105° C(含温升) 工作湿度范围: 20-80%	Storage temperature: Humidity: 储存温度: 25±5° C 储存湿度: ≤60%
Voltage rating 额定电压	400V/AC		

Item 项目	Condition 条件	Specification 规格
Insulation Resistance 绝缘电阻	Measured at 500V DC for 1 minute 测试电压: 500V DC/1分钟	No less than 1000MΩ 不少于1000MΩ
Withstanding voltage 耐电压	Measured at 1500V AC for 1 minute 测试电压: 1500V AC/1分钟	No breakdown, no discharge, leakage current <0.5mA 无击穿、无放电、漏电流<0.5mA
Contact Resistance 接触电阻	Measured at 100mA and no higher than 20mV 在100mA下测量, 用20 mV DC进行测量	Contact resistance: Initial value/ 20 mΩ max After environmental tests/ 40 mΩ max. 接触电阻: 初始值 20 mΩ 以下 测试后 40mΩ 以下
Vibration Resistance 抗振动	Test Frequency: 50-2000 Hz PSD value : 0.04g ² /HZ Test Acceleration: 7.56 G Vibration Direction and Duration: 2 hours each in X, Y, and Z axes 测试频率: 50-2000Hz 信号值:0.04g ² /HZ 测试加速度: 7.56G 振动方向及时间: X轴、Y轴, Z轴方向各工作 2小时	No electrical discontinuity of 1μs or greater 试验过程中未发生1μs瞬断现象, 且外观无损伤, 电气性能正常
Temperature life 高温老化	Temperature温度:105°C Duration时间:250H	Contact resistance: Initial value/ 20 mΩ max After environmental tests/ 40 mΩ max. 接触电阻: 初始值 20 mΩ 以下 测试后 40 mΩ 以下
Salt Spray 盐雾	Temperature:35± 2°C Solution concentration : 5%NaCl PHValue : 6.5 ~ 7.2 Duration : 24hours 温度: 35±2° C 溶液浓度: 5%NaCl PH值: 6.5~7.2 时间: 24小时	Contact resistance: Initial value/ 20 mΩ max After environmental tests/ 40 mΩ max. 接触电阻: 初始值 20 mΩ 以下 测试后 40 mΩ 以下
Durability(Mating/un-mating) 插拔寿命	100 cycles 循环100次	Contact resistance: Initial value/ 20 mΩ max After environmental tests/ 40 mΩ max. 接触电阻: 初始值 20 mΩ 以下 测试后 40 mΩ 以下

WF4191 Series

Order Information 订购信息

Circuit 芯数	Part number 型号			Dimensions 尺寸 (mm)		Package 包装 Qty/Tube 只/管装	Remark 可量产状态
	180°SMT	90°DIP	180°DIP	A	B		
2	WF4191(A)-1WM02SMBT1	WF4191(A)-1WR02SMBT1	WF4191(A)-1WS02SMBT1	9.71	4.19	59	*
3	WF4191(A)-1WM03SMBT1	WF4191(A)-1WR03SMBT1	WF4191(A)-1WS03SMBT1	13.90	8.38	41	*
4	WF4191(A)-1WM04SMBT1	WF4191(A)-1WR04SMBT1	WF4191(A)-1WS04SMBT1	18.09	12.57	32	
5	WF4191(A)-1WM05SMBT1	WF4191(A)-1WR05SMBT1	WF4191(A)-1WS05SMBT1	22.28	16.76	25	*
8	WF4191(A)-1WM08SMBT1	WF4191(A)-1WR08SMBT1	WF4191(A)-1WS08SMBT1	34.85	29.33	16	*
10	WF4191(A)-1WM10SMBT1	WF4191(A)-1WR10SMBT1	WF4191(A)-1WS10SMBT1	43.23	37.71	13	*

Note: * stands for mass production . 注: *代表可量产

Dimensions 尺寸(180° SMT)

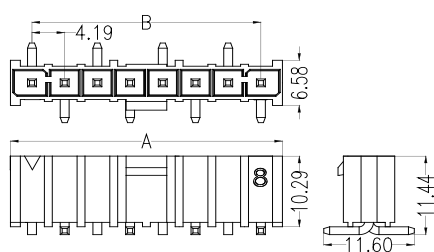

Dimensions 尺寸(90° DIP)

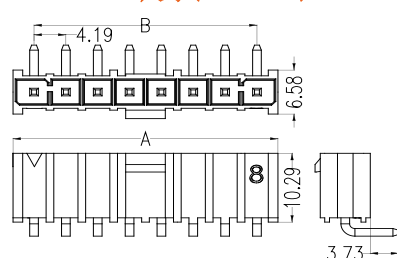

Dimensions 尺寸(180° DIP)

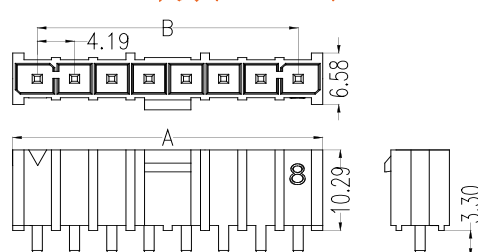

PCB Layout 印刷电路板布局

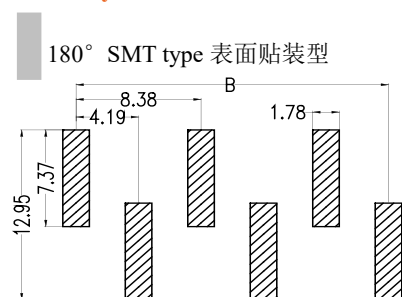

PCB Layout 印刷电路板布局

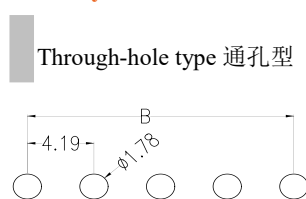

PCB Layout 印刷电路板布局

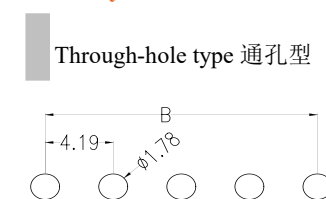

Assembly Schematic 装配示意

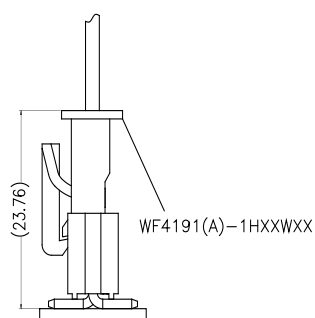

Assembly Schematic 装配示意

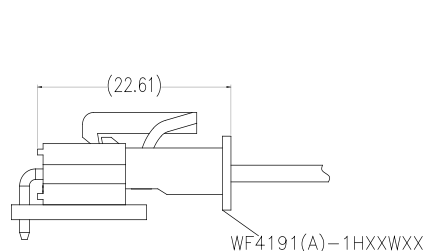

Assembly Schematic 装配示意

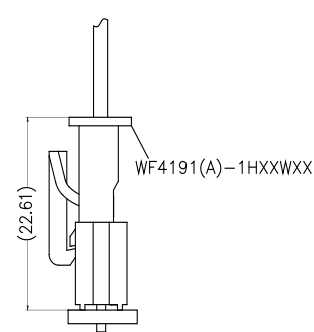

Key Layout Guide 键位说明

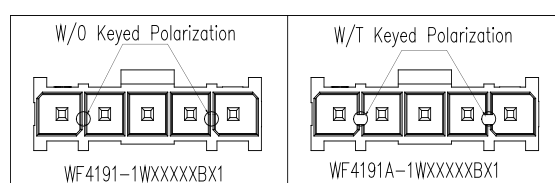

Order Information 订购信息

Circuit 芯数	Part number 型号			Dimensions 尺寸 (mm)		Package 包装 Qty/Tube 只/管装	Remark 可量产状态
	180°SMT	90°DIP	180°DIP	A	B		
2*2	WF4191(A)-2WM02SMBT1	WF4191(A)-2WR02SMBT1	WF4191(A)-2WS02SMBT1	9.71	4.19	59	*
2*3	WF4191(A)-2WM03SMBT1	WF4191(A)-2WR03SMBT1	WF4191(A)-2WS03SMBT1	13.90	8.38	41	
2*4	WF4191(A)-2WM04SMBT1	WF4191(A)-2WR04SMBT1	WF4191(A)-2WS04SMBT1	18.09	12.57	32	*
2*5	WF4191(A)-2WM05SMBT1	WF4191(A)-2WR05SMBT1	WF4191(A)-2WS05SMBT1	22.28	16.76	25	*
2*8	WF4191(A)-2WM08SMBT1	WF4191(A)-2WR08SMBT1	WF4191(A)-2WS08SMBT1	34.85	29.33	16	
2*10	WF4191(A)-2WM10SMBT1	WF4191(A)-2WR10SMBT1	WF4191(A)-2WS10SMBT1	43.23	37.71	13	*
2*15	WF4191(A)-2WM15SMBT1	WF4191(A)-2WR15SMBT1	WF4191(A)-2WS15SMBT1	64.18	58.66	9	*

Note: * stands for mass production . 注: *代表可量产

Dimensions 尺寸(180° SMT)

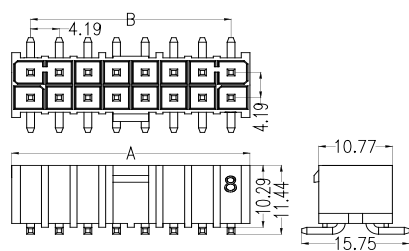

Dimensions 尺寸(90° DIP)

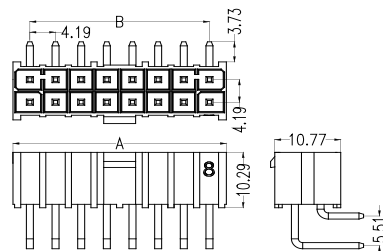

Dimensions 尺寸(180° DIP)

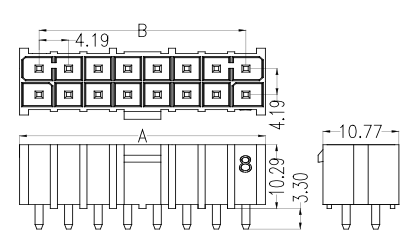

PCB Layout 印刷电路板布局

180° SMT type 表面贴装型

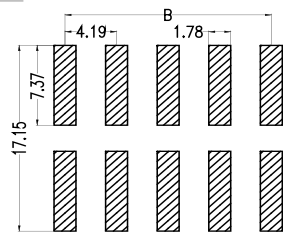

PCB Layout 印刷电路板布局

Through-hole type 通孔型

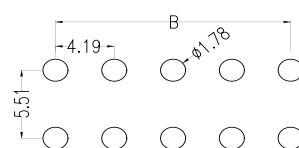

PCB Layout 印刷电路板布局

Through-hole type 通孔型

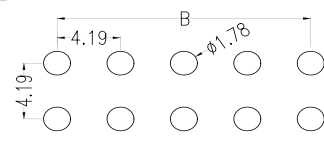

Assembly Schematic 装配示意

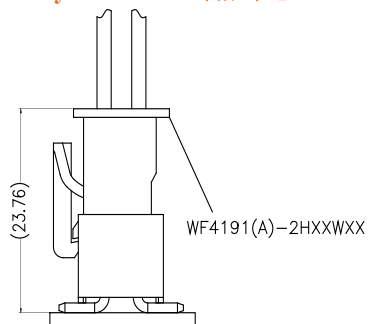

Assembly Schematic 装配示意

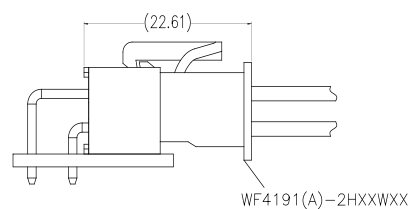

Assembly Schematic 装配示意

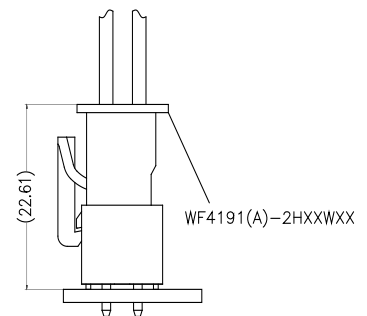

Key Layout Guide 键位说明

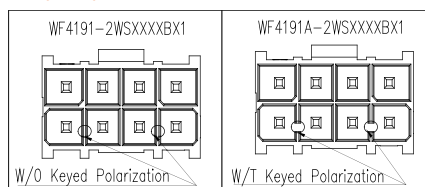

WF4191 Series

Order Information 订购信息

Circuit 芯数	Part number 型号				Dimensions 尺寸 (mm)		Package 包装 Qty/Bag 只/袋装	Remark 可量产状态			
	TYPE-1	TYPE-2	TYPE-3	TYPE-4	A	B		TYPE-1	TYPE-2	TYPE-3	TYPE-4
2	WF4191(A)-1H02W01	WF4191(A)-1H02W02	WF4191(A)-1H03W03	WF4191(A)-1H04W04	12.45	4.19	500	*			
3	WF4191(A)-1H03W01	WF4191(A)-1H03W02	WF4191(A)-1H03W03	WF4191(A)-1H04W04	13.59	8.38	500	*			
4	WF4191(A)-1H04W01	WF4191(A)-1H04W02	WF4191(A)-1H04W03	WF4191(A)-1H04W04	17.78	12.57	500				
5	WF4191(A)-1H05W01	WF4191(A)-1H05W02	WF4191(A)-1H05W03	WF4191(A)-1H05W04	21.97	16.76	500	*	*		
8	WF4191(A)-1H08W01	WF4191(A)-1H08W02	WF4191(A)-1H08W03	WF4191(A)-1H08W04	34.54	29.33	300	*			
10	WF4191(A)-1H10W01	WF4191(A)-1H10W02	WF4191(A)-1H10W03	WF4191(A)-1H10W04	42.92	37.71	300	*			
15	WF4191(A)-1H15W01	WF4191(A)-1H15W02	WF4191(A)-1H15W03	WF4191(A)-1H15W04	63.87	58.66	100	*			

Note: * stands for mass production . 注: *代表可量产

Dimensions 尺寸 (TYPE-1)

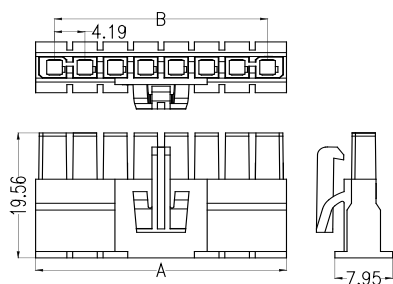

Key Layout Guide 键位说明

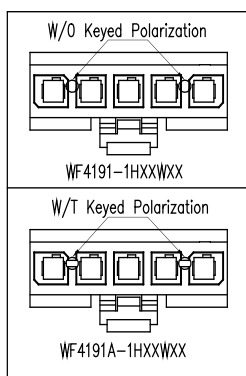

Dimensions 尺寸 (TYPE-2)

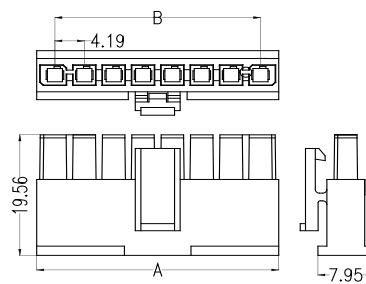

Dimensions 尺寸 (TYPE-3)

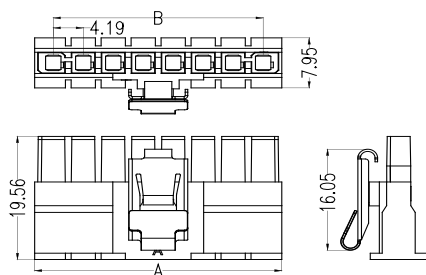

Dimensions 尺寸 (TYPE-4)

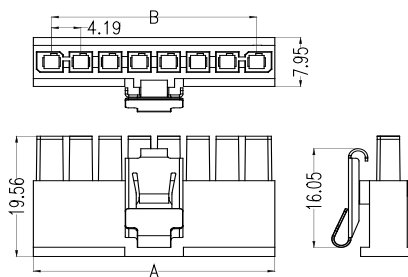

Order Information 订购信息

Circuit 芯数	Part number 型号				Dimensions 尺寸 (mm)		Package 包装 Q'ty/Bag 只/袋装	Remark 可量产状态			
	TYPE-1	TYPE-2	TYPE-3	TYPE-4	A	B		TYPE-1	TYPE-2	TYPE-3	TYPE-4
2*2	WF4191(A)-2H02W01	WF4191(A)-2H02W02	WF4191(A)-2H03W03	WF4191(A)-2H04W04	12.45	4.19	500	*	*		
2*3	WF4191(A)-2H03W01	WF4191(A)-2H03W02	WF4191(A)-2H03W03	WF4191(A)-2H04W04	13.59	8.38	500				
2*4	WF4191(A)-2H04W01	WF4191(A)-2H04W02	WF4191(A)-2H04W03	WF4191(A)-2H04W04	17.78	12.57	500				
2*5	WF4191(A)-2H05W01	WF4191(A)-2H05W02	WF4191(A)-2H05W03	WF4191(A)-2H05W04	21.97	16.76	500	*	*		
2*8	WF4191(A)-2H08W01	WF4191(A)-2H08W02	WF4191(A)-2H08W03	WF4191(A)-2H08W04	34.54	29.33	300				
2*10	WF4191(A)-2H10W01	WF4191(A)-2H10W02	WF4191(A)-2H10W03	WF4191(A)-2H10W04	42.92	37.71	300	*	*		
2*15	WF4191(A)-2H15W01	WF4191(A)-2H15W02	WF4191(A)-2H15W03	WF4191(A)-2H15W04	63.87	58.66	100	*	*		

Note: * stands for mass production . 注: *代表可量产

Dimensions 尺寸 (TYPE-1)

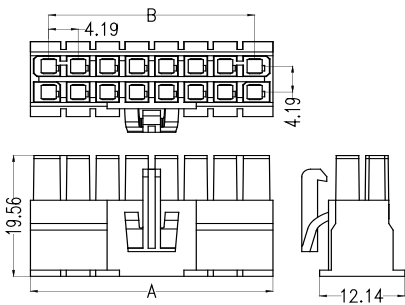

Key Layout Guide 键位说明

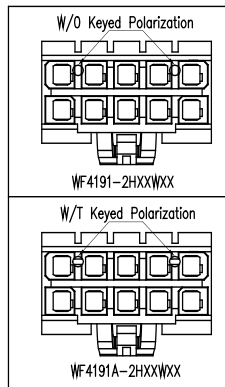

Dimensions 尺寸 (TYPE-2)

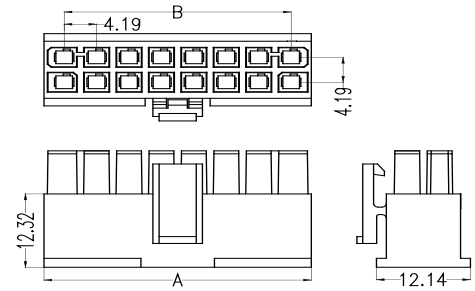

Dimensions 尺寸 (TYPE-3)

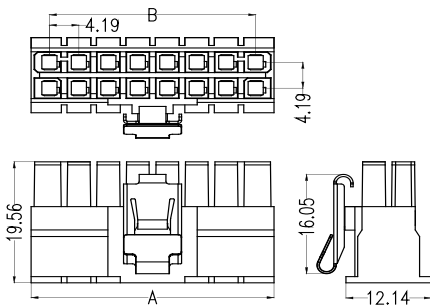

Dimensions 尺寸 (TYPE-4)

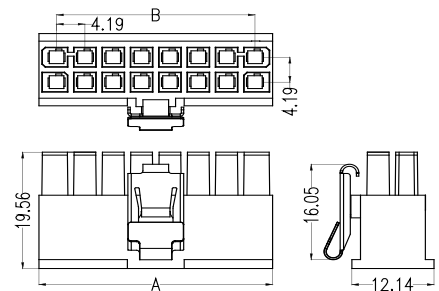

WF4191 Series

Order Information 订购信息

Circuit 芯数	Part number 型号		Dimensions 尺寸 (mm)		Package 包装 Qty/Tube 只/管装	Remark 可量产状态
	180°SMT(TYPE-1)	180°DIP(TYPE-1)	A	B		
2	WF4191-1FM02SMBT1	WF4191-1FS02SMBT1	10.41	4.19	55	
3	WF4191-1FM03SMBT1	WF4191-1FS03SMBT1	14.60	8.38	39	*
4	WF4191-1FM04SMBT1	WF4191-1FS04SMBT1	18.79	12.57	30	
5	WF4191-1FM05SMBT1	WF4191-1FS05SMBT1	22.98	16.76	25	*
8	WF4191-1FM08SMBT1	WF4191-1FS08SMBT1	35.55	29.33	16	*
10	WF4191-1FM10SMBT1	WF4191-1FS10SMBT1	43.93	37.71	13	*

Note: * stands for mass production. 注: *代表可量产

Dimensions 尺寸(180° SMT)

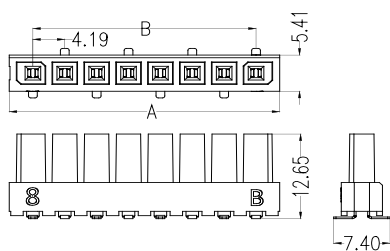

PCB Layout 印刷电路板布局

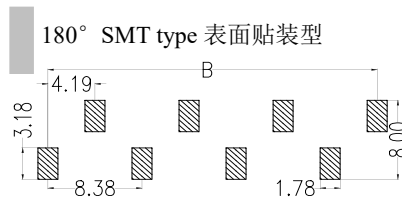

Dimensions 尺寸(180° DIP)

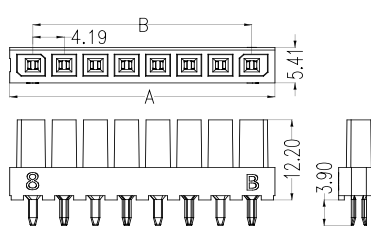

PCB Layout 印刷电路板布局

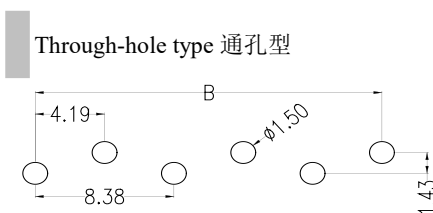

Order Information 订购信息

Circuit 芯数	Part number 型号		Dimensions 尺寸 (mm)		Package 包装 Qty/Reel 只/卷装	Remark 可量产状态
	180°SMT(TYPE-2)	180°DIP(TYPE-2)	A	B		
2	WF4191-1FM02SMBT2	WF4191-1FS02SMBT2	19.56	4.19	29	*
3	WF4191-1FM03SMBT2	WF4191-1FS03SMBT2	23.75	8.38	24	
4	WF4191-1FM04SMBT2	WF4191-1FS04SMBT2	27.94	12.57	20	
5	WF4191-1FM05SMBT2	WF4191-1FS05SMBT2	32.13	16.76	18	*
8	WF4191-1FM08SMBT2	WF4191-1FS08SMBT2	44.7	29.33	12	
10	WF4191-1FM10SMBT2	WF4191-1FS10SMBT2	53.08	37.71	10	*

Note: * stands for mass production. 注: *代表可量产

Dimensions 尺寸(180° SMT)

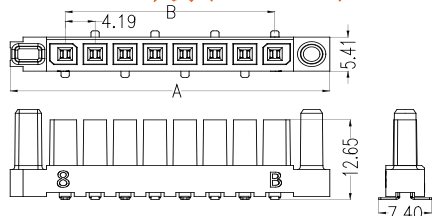

PCB Layout 印刷电路板布局

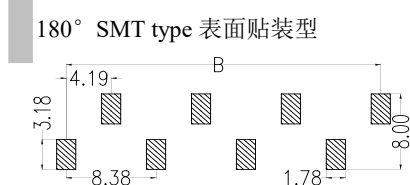

Dimensions 尺寸(180° DIP)

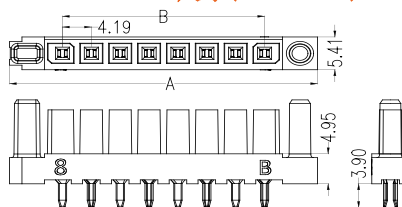

PCB Layout 印刷电路板布局

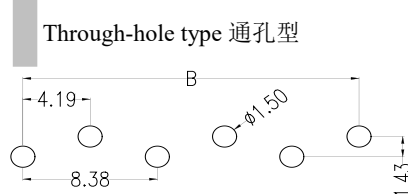

Order Information 订购信息

Circuit 芯数	Part number 型号		Dimensions 尺寸 (mm)		Package 包装 Qty/Tube 只/管装	Remark 可量产状态
	180°SMT(TYPE-1)	180°DIP(TYPE-1)	A	B		
2*2	WF4191-2FM02SMBT1	WF4191-2FS02SMBT1	9.40	4.19	61	
2*3	WF4191-2FM03SMBT1	WF4191-2FS03SMBT1	13.59	8.38	42	*
2*4	WF4191-2FM04SMBT1	WF4191-2FS04SMBT1	17.78	12.57	32	*
2*5	WF4191-2FM05SMBT1	WF4191-2FS05SMBT1	21.97	16.76	26	*
2*8	WF4191-2FM08SMBT1	WF4191-2FS08SMBT1	34.54	29.33	16	*
2*10	WF4191-2FM10SMBT1	WF4191-2FS10SMBT1	42.92	37.71	13	
2*15	WF4191-2FM15SMBT1	WF4191-2FS15SMBT1	63.87	58.66	9	

Note: * stands for mass production. 注: *代表可量产

Dimensions 尺寸(180° SMT)

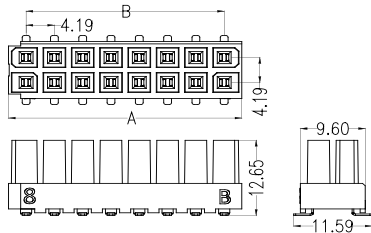

PCB Layout 印刷电路板布局

180° SMT type 表面贴装型

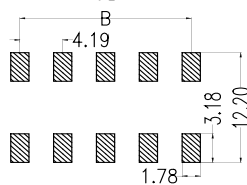

Dimensions 尺寸(180° DIP)

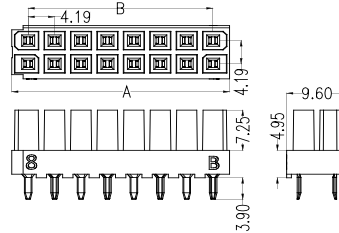

PCB Layout 印刷电路板布局

Through-hole type 通孔型

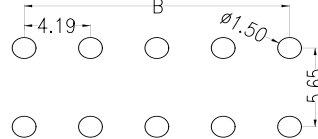

Order Information 订购信息

Circuit 芯数	Part number 型号		Dimensions 尺寸 (mm)		Package 包装 Qty/Reel 只/卷装	Remark 可量产状态
	180°SMT (TYPE-2)	180°DIP (TYPE-2)	A	B		
2*2	WF4191-2FM02SMBT2	WF4191-2FS02SMBT2	9.40	4.19	29	*
2*3	WF4191-2FM03SMBT2	WF4191-2FS03SMBT2	13.59	8.38	24	
2*4	WF4191-2FM04SMBT2	WF4191-2FS04SMBT2	17.78	12.57	20	*
2*5	WF4191-2FM05SMBT2	WF4191-2FS05SMBT2	21.97	16.76	18	*
2*8	WF4191-2FM08SMBT2	WF4191-2FS08SMBT2	34.54	29.33	12	*
2*10	WF4191-2FM10SMBT2	WF4191-2FS10SMBT2	42.92	37.71	10	*
2*15	WF4191-2FM15SMBT2	WF4191-2FS15SMBT2	63.87	58.66	7	*

Note: * stands for mass production. 注: *代表可量产

Dimensions 尺寸(90° DIP)

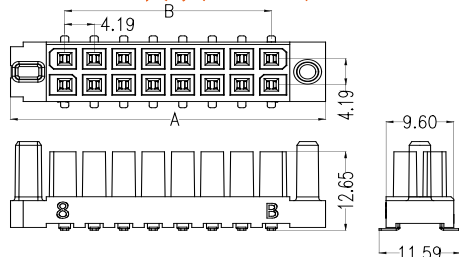

PCB Layout 印刷电路板布局

180° SMT type 表面贴装型

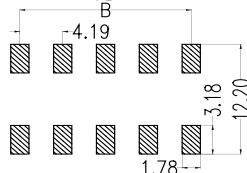

Dimensions 尺寸(180° DIP)

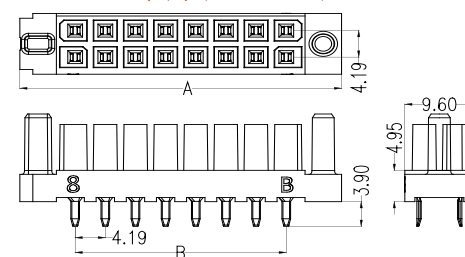

PCB Layout 印刷电路板布局

Through-hole type 通孔型

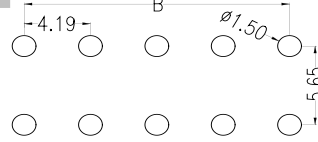

WF4191 Series

Order Information 订购信息

Circuit 芯数	Part number 型号		Dimensions 尺寸 (mm)		Package 包装 Qty/Tube 只/管装	Remark 可量产状态
	W/O KEY	W/T KEY	A	B		
2*2	WF4191B-2WS02SMBT4	WF4191C-2WS02SMBT4	9.71	4.19	28	
2*3	WF4191B-2WS03SMBT4	WF4191C-2WS03SMBT4	13.9	8.38	23	
2*4	WF4191B-2WS04SMBT4	WF4191C-2WS04SMBT4	18.09	12.57	19	
2*5	WF4191B-2WS05SMBT4	WF4191C-2WS05SMBT4	22.28	16.76	17	
2*8	WF4191B-2WS08SMBT4	WF4191C-2WS08SMBT4	34.85	29.33	12	
2*10	WF4191B-2WS10SMBT4	WF4191C-2WS10SMBT4	43.23	37.71	10	
2*15	WF4191B-2WS15SMBT4	WF4191C-2WS15SMBT4	64.18	58.66	7	

Note: * stands for mass production. 注: *代表可量产

Dimensions 尺寸 (90° DIP)

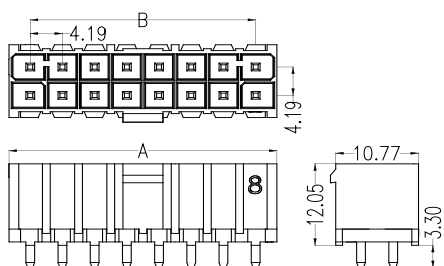

PCB Layout 印刷电路板布局

180° SMT type 表面贴装型

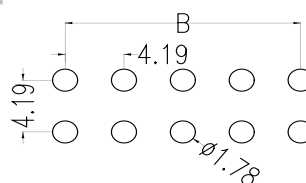

Assembly Schematic 装配示意

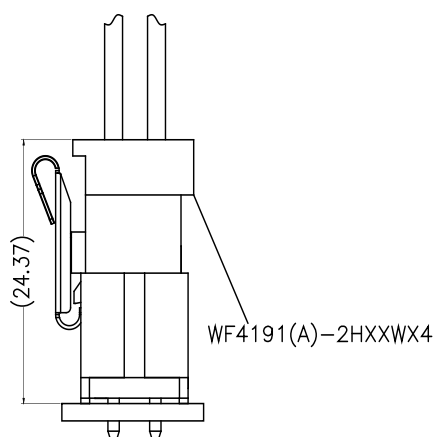

Key Layout Guide 键位说明

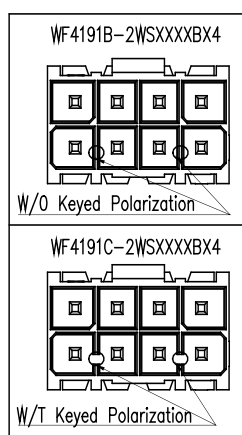

Order Information 订购信息

Circuit 芯数	Part number 型号			Dimensions 尺寸 (mm)		Package 包装 Q'ty/Tube 只/管装	Remark 可量产状态
	180°SMT	90°DIP	180°DIP	A	B		
2	WF4191D-1WM02SMBT1	WF4191D-1WR02SMBT1	WF4191D-1WS02SMBT1	20.65	4.19	28	
3	WF4191D-1WM03SMBT1	WF4191D-1WR03SMBT1	WF4191D-1WS03SMBT1	24.84	8.38	23	
4	WF4191D-1WM04SMBT1	WF4191D-1WR04SMBT1	WF4191D-1WS04SMBT1	29.03	12.57	19	
5	WF4191D-1WM05SMBT1	WF4191D-1WR05SMBT1	WF4191D-1WS05SMBT1	33.22	16.76	17	
8	WF4191D-1WM08SMBT1	WF4191D-1WR08SMBT1	WF4191D-1WS08SMBT1	45.79	29.33	12	
10	WF4191D-1WM10SMBT1	WF4191D-1WR10SMBT1	WF4191D-1WS10SMBT1	54.17	37.71	10	

Note: * stands for mass production . 注: *代表可量产

Dimensions 尺寸(180° SMT)

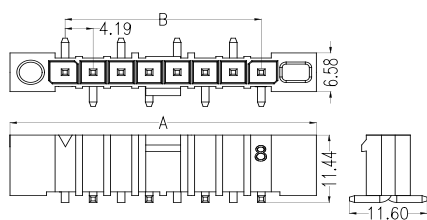

Dimensions 尺寸(90° DIP)

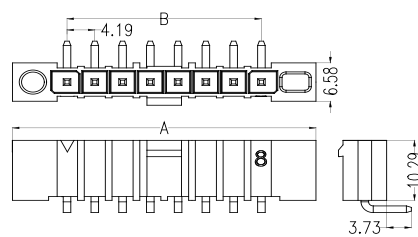

Dimensions 尺寸(180° DIP)

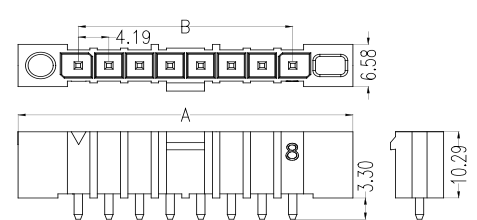

PCB Layout 印刷电路板布局

180° SMT type 表面贴装型

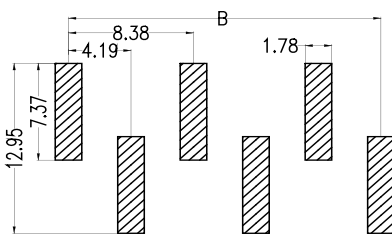

PCB Layout 印刷电路板布局

Through-hole type 通孔型

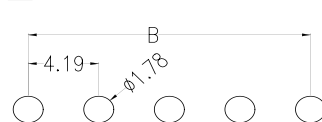

PCB Layout 印刷电路板布局

Through-hole type 通孔型

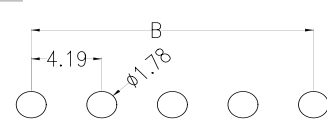

Assembly Schematic 装配示意

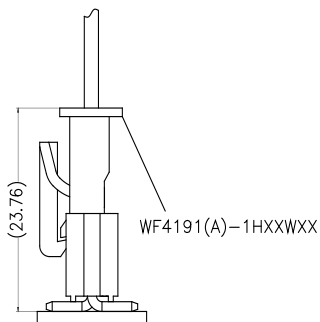

Assembly Schematic 装配示意

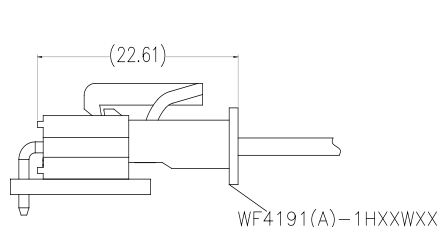

Assembly Schematic 装配示意

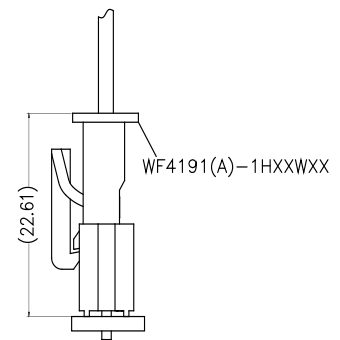

WF4191 Series

Order Information 订购信息

Circuit 芯数	Part number 型号			Dimensions 尺寸 (mm)		Package 包装 Q'ty/Tube 只/管装	Remark 可量产状态
	180°SMT	90°DIP	180°DIP	A	B		
2*2	WF4191D-2WM02SMBT1	WF4191D-2WR02SMBT1	WF4191D-2WS02SMBT1	20.65	4.19	28	
2*3	WF4191D-2WM03SMBT1	WF4191D-2WR03SMBT1	WF4191D-2WS03SMBT1	24.84	8.38	23	
2*4	WF4191D-2WM04SMBT1	WF4191D-2WR04SMBT1	WF4191D-2WS04SMBT1	29.03	12.57	19	
2*5	WF4191D-2WM05SMBT1	WF4191D-2WR05SMBT1	WF4191D-2WS05SMBT1	33.22	16.76	17	
2*8	WF4191D-2WM08SMBT1	WF4191D-2WR08SMBT1	WF4191D-2WS08SMBT1	45.79	29.33	12	
2*10	WF4191D-2WM10SMBT1	WF4191D-2WR10SMBT1	WF4191D-2WS10SMBT1	54.17	37.71	10	
2*15	WF4191D-2WM15SMBT1	WF4191D-2WR15SMBT1	WF4191D-2WS15SMBT1	75.12	58.66	7	

Note: * stands for mass production . 注: *代表可量产

Dimensions 尺寸(180° SMT)

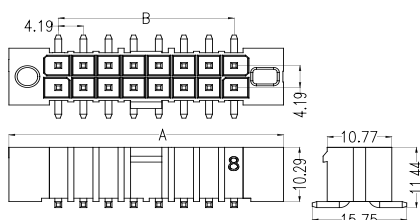

Dimensions 尺寸(90° DIP)

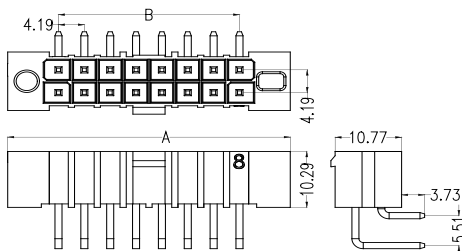

Dimensions 尺寸(180° DIP)

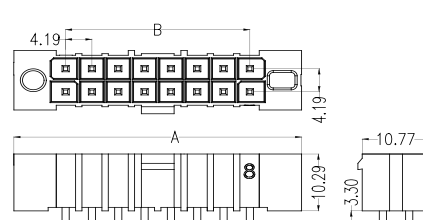

PCB Layout 印刷电路板布局

180° SMT type 表面贴装型

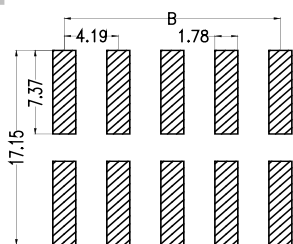

PCB Layout 印刷电路板布局

Through-hole type 通孔型

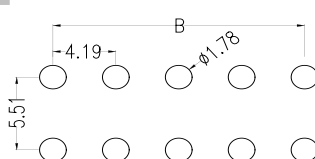

PCB Layout 印刷电路板布局

Through-hole type 通孔型

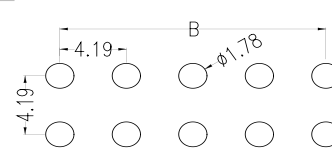

Assembly Schematic 装配示意

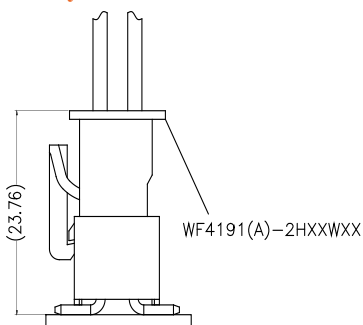

Assembly Schematic 装配示意

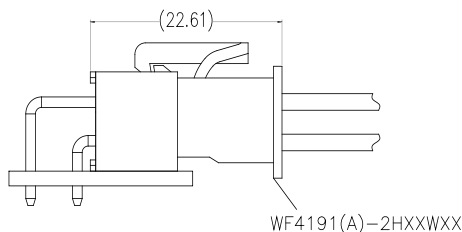

Assembly Schematic 装配示意

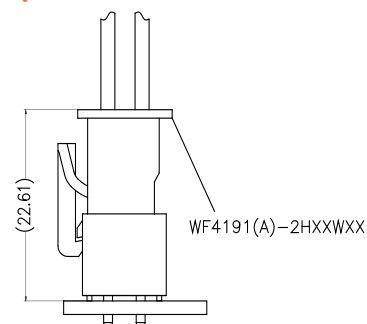

Dimensions 尺寸(180° DIP)

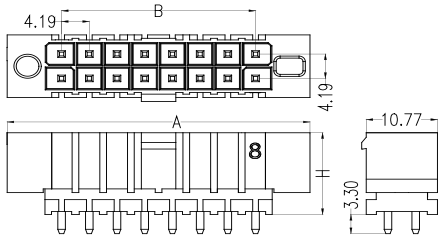

PCB Layout 印刷电路板布局

Through-hole type 通孔型

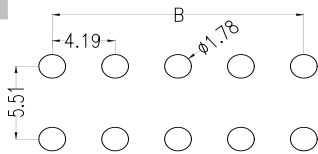

Assembly Schematic 装配示意

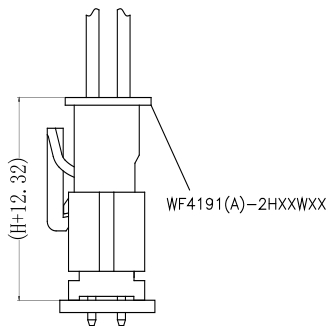

Adaptor Terminal 适配端子

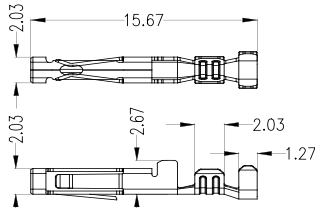

Part number 型号	Suitable wire diameter 适配线径
WF4191-TXXX01	16-18AWG
WF4191-TXXX02	20-24AWG
WF4191-TXXX03	24-26AWG

Terminal Crimping Specification 端子压接规范

型号 Model number	电线类型 Wire type	电线规格 Wire size	线缆 OD (mm) Cable OD (mm)	剥线长度 (mm) Strip length (mm)	导体铆压 (A-A) Conductor crimp		导体铆压 (B-B) Conductor crimp	
					压接宽度CBm1 Crimping height CBm1±0.05mm	压接高度 Crimping height CH1±0.03mm	压接宽度CBm2 Crimping width CBm2±0.05mm	压接高度CH2 Crimping width CH2±0.08mm
WF4191-TXXX01	3398	16AWG	2.40	3.50±0.10	2.06	1.34	2.40	2.90
	UL1015	18AWG	2.80		1.82	1.42	2.80	2.80
WF4191-TXXX02	UL1015	20AWG	2.60		1.50	1.11	2.60	2.80
	UL1015	22AWG	2.40		1.37	0.94	2.40	2.60
WF4191-TXXX03	UL1332	24AWG	1.21		1.37	0.88	1.40	1.40
	UL1332	24AWG	1.21		1.29	0.96	1.30	1.40
	UL1061	26AWG	1.55±0.25		1.25	0.85	1.80	1.65

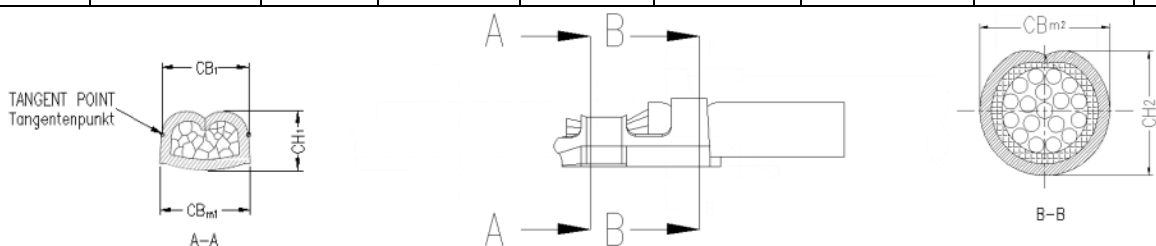

Order Information 订购信息

Circuit 芯数	Part number 型号	Dimensions 尺寸 (mm)			Package 包装 Qty/Tube 只/管装	Remark 可量产状态
		A	B	H		
2*2	WF4191E-2WS02SMBT1	20.65	4.19	14.05	28	
	WF4191E-2WS02SMBT2			15.05		
	WF4191E-2WS02SMBT3			20.05		
2*3	WF4191E-2WS03SMBT1	24.84	8.38	14.05	23	
	WF4191E-2WS03SMBT2			15.05		
	WF4191E-2WS03SMBT3			20.05		
2*4	WF4191E-2WS04SMBT1	29.03	12.57	14.05	19	
	WF4191E-2WS04SMBT2			15.05		
	WF4191E-2WS04SMBT3			20.05		
2*5	WF4191E-2WS05SMBT1	33.22	16.76	14.05	17	
	WF4191E-2WS05SMBT2			15.05		
	WF4191E-2WS05SMBT3			20.05		
2*8	WF4191E-2WS08SMBT1	45.79	29.33	14.05	12	
	WF4191E-2WS08SMBT2			15.05		
	WF4191E-2WS08SMBT3			20.05		
2*10	WF4191E-2WS10SMBT1	54.17	37.71	14.05	10	
	WF4191E-2WS10SMBT2			15.05		
	WF4191E-2WS10SMBT3			20.05		
2*15	WF4191E-2WS15SMBT1	75.12	58.66	14.05	7	
	WF4191E-2WS15SMBT2			15.05		
	WF4191E-2WS15SMBT3			20.05		

Note: * stands for mass production . 注: *代表可量产

WF4191 Series

Model Numbering 型号命名

WF4191	(X)	-	X	WX	XX	SM	B	T	1
(1)	(2)		(3)	(4)	(5)	(6)	(7)	(8)	(9)
(1) Series (系列): Wafer 4.19mm Series						(6) Contact Plating (电镀): SM=Matte Tin			
(2) Specification Code (规格代码): Blank=W/0 Keyed Polarization、A=W/T Keyed Polarization、B=Add Plastic,W/0 Keyed Polarization、C=Add Plastic,W/T Keyed Polarization、D=W/T Localizable Hole、E=Add Plastic,W/T Localizable Hole						(7) Color (颜色): B=Black			
(3) Number of rows (排数): 1=Single Row、2=Double Row						(8) Packing (包装): T=Tube			
(4) Terminal type (端子形态): WS=180° DIP、WR=90° DIP、WM=180° SMT						(9) Running number (流水码)			
(5) Positions (位数): 02=2P.....10=10P (Single Row)、2*2=2P.....2*15=30P (Double Row)									

WF4191	(X)	-	X	H	XX	W	0	X
(1)	(2)		(3)	(4)	(5)	(6)	(7)	(8)
(1) Series (系列): Wafer 4.19mm Series						(5) Positions (位数): 02=2P.....10=10P (Single Row)、2*2=2P.....2*15=30P (Double Row)		
(2) Specification Code (规格代码): A=W/T Keyed Polarization、Blank=W/0 Keyed Polarization						(6) Color (颜色): W=White		
(3) Number of rows (排数): 1=Single Row、2=Double Row						(7) Packing (包装): 0=PE Bag		
(4) Product type (产品类型): H=Crimp Type Housing						(8) Running number (流水码): 1=TYPE-1、2=TYPE-2、3=TYPE-3、4=TYPE-4		

WF4191	-	X	F	X	XX	SM	B	T	X
(1)		(2)	(3)	(4)	(5)	(6)	(7)	(8)	(9)
(1) Series (系列): Wafer 4.19mm Series						(6) Contact Plating (电镀): SM=Matte Tin			
(2) Number of rows (排数): 1=Single Row、2=Double Row						(7) Color (颜色): B=Black			
(3) Product type (产品类型): F=Female						(8) Packing (包装): T=Tube			
(4) Terminal type (端子形态): S=180° DIP、M=180° SMT						(9) Running number (流水码): 1=W/0 Localizable Post、2=W/T Localizable Post			
(5) Positions (位数): 02=2P.....10=10P (Single Row)、2*2=2P.....2*15=30P (Double Row)									

Contact Us 联系我们

维峰电子股份有限公司(总部)
 WCON ELECTRONICS CO.,LTD(HQ)
 地址:广东省东莞市虎门镇大宁文明路15号
 Add :No.15,Wenming Road,Danling Community, Humen Town,
 Dongguan, Guangdong.523930, China

昆山维康电子有限公司
 KUNSHAN WCON ELECTRONICIS CO.,LTD(East of China)
 地址:江苏昆山千灯镇汶浦中路169号
 Add : No.169, WenPu Middle Road, QianDeng Town, Kunshan
 City, Jiangsu Province, China

合肥维峰电子有限公司
 HEFEI WCON ELECTRONICIS CO.,LTD
 地址:安徽合肥市高新技术开发区绿城科技园E栋2楼
 Add : 2F, Building E, Greentown Science Park,High-tech Develop-
 ment Zone, Hefei, Anhui,China

维康电子(泰国)有限公司
 WCON ELECTRONICS (Thailand) CO.,LTD
 地址:泰国巴真武里府西玛铺县华瓦区洛加纳工业园
 Add: VG3C+H57, Hua Wa, Si Maha Phot District, Prachin Buri
 25140, Thailand

销售联系方式 Contacts Information

国际客户部 International sales department
 salesdg01@wcon.com
 salesdg05@wcon.com

大客户专线 Major customer dedicated department
 华南: salesdg28@wcon.com
 华东: salesks@wcon.com

中小客户专线 Public Customer hot line
 华南: salesdg10@wcon.com
 华东: salesks01@wcon.com

网络销售 Online sales department
 salesdg26@wcon.com



Official Website



Product e-catalog



WeChat Public#



TikTok Public#