

# HSF

NOTES:  
 Rated Current: 1.5AMP.(20°C,1\*2P-1\*15P)  
 1.0AMP.(20°C,1\*16P-1\*50P)  
 Contact Resistance:20mΩ Max.  
 Withstand Voltage:500V AC/DC  
 Insulation Resistance:1000MΩ Min.  
 Operation Temperature: -40°C to +125°C(Gold Plating)

Contact Material: Copper Alloy  
 Contact Plating: Au Over 30u" Min Ni  
 Insulator Material: PA9T+G.F UL94V-0 BK

## Ordering Information

2320T-1 XX M XX C U N X X

Plastic Row  
 No. of Pins  
 Per Row:02-50  
 Welding Type  
 M=SMT  
 Contact Plating  
 G0=Gold Flash  
 G3=10u"Au, BG3=8u"PdNi+2u"Au  
 G4=15u"Au, BG4=13u"PdNi+2u"Au  
 G5=30u"Au, BG5=28u"PdNi+2u"Au  
 Logo  
 N=W/O Logo  
 Contact Type  
 U=U Type  
 Insulator Material  
 C=PA9T  
 Series No.  
 1=TYPE 1  
 2=TYPE 2  
 Packing:  
 T=Tube  
 R=Tape&Reel+CAP  
 P=Tube+CAP

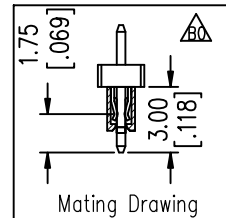
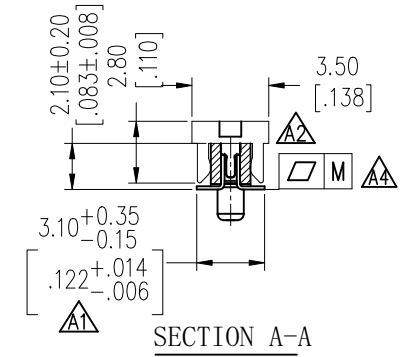
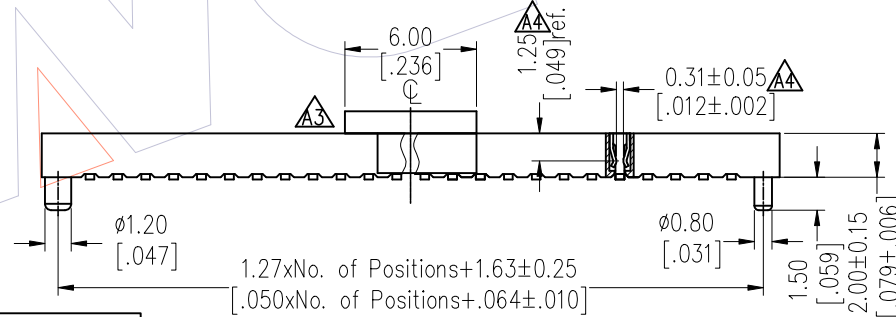
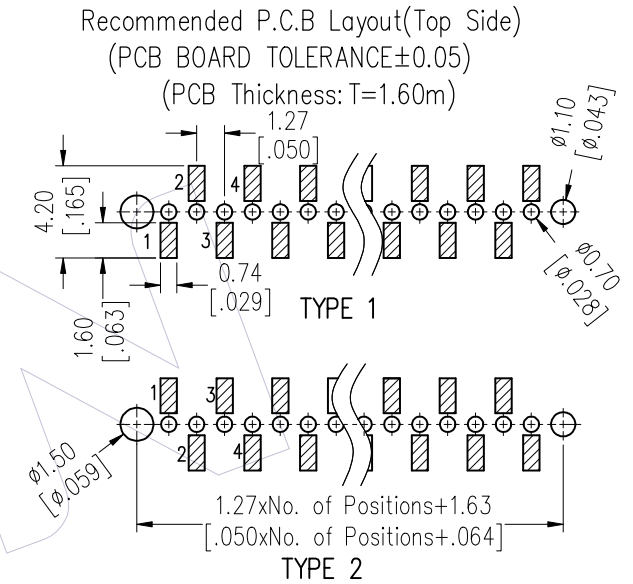
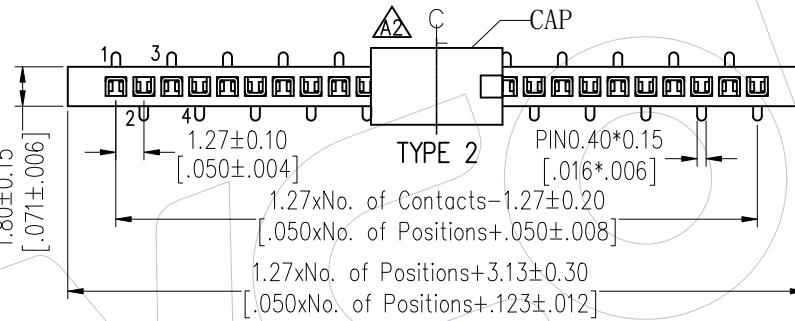
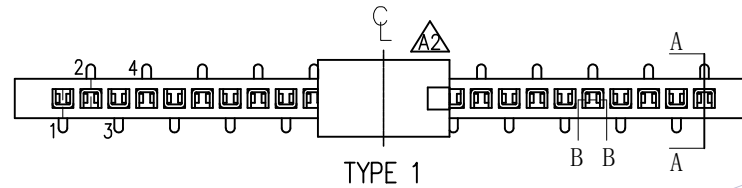

Item	Pitch	Mating	DIM.B
Standard	1.27	1310/1315/1320	3.00
Alternate			

Pin(Per Row)	TITLE			PART NO.		
	2-15P	16-30P	31-40P	TYPE 1	2320T-1XXMXXCUNX1	
M	0.10	0.15	0.18	TYPE 2	2320T-1XXMXXCUNX2	

REV	DATE	MODIFICATION DESCRIPTION	CHANGE	OPERATION	DRAW	DATE	SCALE	FIT	PART NO.
B0	2025/12/11	Standardization Drawing	BAO	OPERATION	BAO	2025/12/11	UNIT	mm	SEE TABLE
A5	2023/02/03	Modify Flatness	XSR	x.X ±0.40	CHECK	2025/12/11	SIZE	A4	TITLE: 1.27mm Female Header Single Row SMT H=2.0 With different post
A4	2020/06/24	Add DIM.&Table;Modify 02~50PIN to 02~40PIN	XSR	x.XX ±0.25	TANG	2025/12/11	SHEET	1/4	Customer NO.
A0	2012/07/05	NEW	-----	x.XXX ±0.15	APPROVE	2025/12/11	PROJ.	⌀	
				Angle ± 3°	Steven Zhao				
				DIM TOL					

**WCON**  
 Http: www.wcon.com  
 WCON-Dongguan Tel: +86 769 85358920 Fax: +86 769 85358915 E-mail: sales@wcon.com  
 WCON-Kunshan Tel: +86 512 57468408 Fax: +86 512 57468468 E-mail: salesks@wcon.com

**HSF**

**△ Packing:**

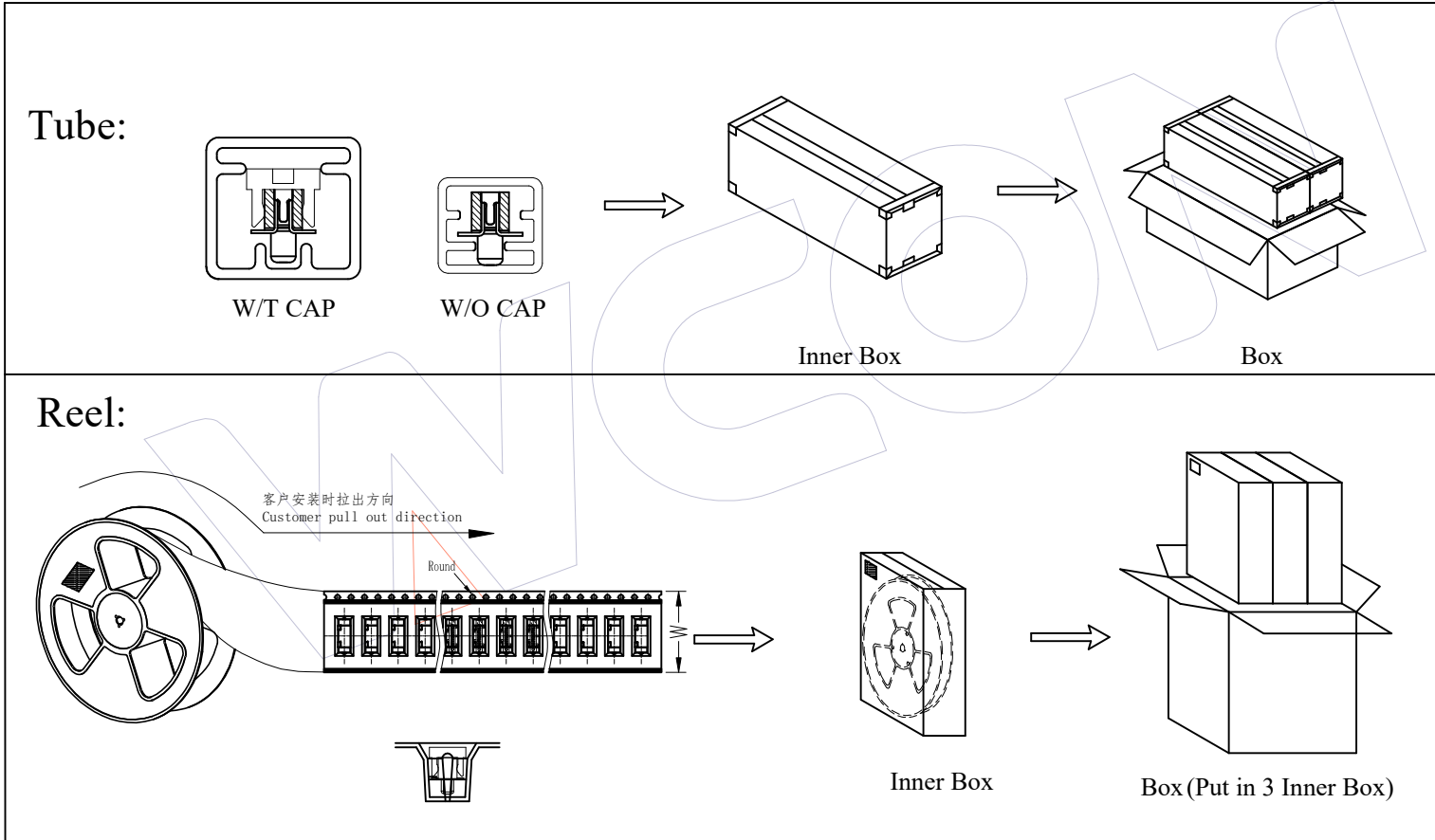

B0	2025/12/11	Standardization Drawing	BAO	OPERATION		DRAW	DATE	SCALE	FIT	PART NO.	
A5	2023/02/03	Modify Flatness	XSR	x.x	±0.40	BAO	2025/12/11	UNIT	mm	SEE TABLE	
A4	2020/06/24	Add DIM.&Table;Modify 02~50PIN to 02~40PIN	XSR	x.xx	±0.25	CHECK	DATE	SIZE	A4	TITLE:	
A0	2012/07/05	NEW	-----	x.xxx	±0.15	TANG	2025/12/11	SHEET	4/4	1.27mm Female Header Single Row SMT H=2.0 With different post	
REV	DATE	MODIFICATION DESCRIPTION	CHANGE	Angle	± 3'	APPROVE	DATE	PROJ.	⌀	Customer NO.	
				DIM	TOL	Steven Zhao	2025/12/11				

**WCON**  
Http: [www.wcon.com](http://www.wcon.com)

WCON-Dongguan      WCON-Kunshan  
Tel: +86 769 85358920      Tel: +86 512 57468408  
Fax: +86 769 85358915      Fax: +86 512 57468468  
E-mail: [sales@wcon.com](mailto:sales@wcon.com)      E-mail: [salesks@wcon.com](mailto:salesks@wcon.com)

# HSF

## Packaging Quantity Refers To The Following Table

W/T CAP

PINS	Q' ty/Tube	Q' ty/Inner Box	Q' ty/Box
2	/	/	/
3	83	29,880	59,760
4	70	25,200	50,400
5	61	21,960	43,920
6	53	19,080	38,160
7	48	17,280	34,560
8	43	15,480	30,960
9	39	14,040	28,080
10	36	12,960	25,920
11	33	11,880	23,760
12	31	11,160	22,320
13	29	10,440	20,880
14	27	9,720	19,440
15	26	9,360	18,720
16	24	8,640	17,280
17	23	8,280	16,560
18	22	7,920	15,840
19	21	7,560	15,120
20	20	7,200	14,400
21	19	6,840	13,680
22	18	6,480	12,960
23	17	6,120	12,240
24	17	6,120	12,240
25	16	5,760	11,520
26	16	5,760	11,520

W/T CAP

PINS	Q' ty/Tube	Q' ty/Inner Box	Q' ty/Box
27	15	5,400	10,800
28	14	5,040	10,080
29	14	5,040	10,080
30	14	5,040	10,080
31	13	4,680	9,360
32	13	4,680	9,360
33	12	4,320	8,640
34	12	4,320	8,640
35	12	4,320	8,640
36	11	3,960	7,920
37	11	3,960	7,920
38	11	3,960	7,920
39	11	3,960	7,920
40	10	3,600	7,200
41	10	3,600	7,200
42	10	3,600	7,200
43	9	3,240	6,480
44	9	3,240	6,480
45	9	3,240	6,480
46	9	3,240	6,480
47	9	3,240	6,480
48	9	3,240	6,480
49	8	2,880	5,760
50	8	2,880	5,760

W/O CAP

PINS	Q' ty/Tube	Q' ty/Inner Box	Q' ty/Box
2	2000/Tray	/	96,000
3	83	41,500	83,000
4	70	35,000	70,000
5	61	30,500	61,000
6	53	26,500	53,000
7	48	24,000	48,000
8	43	21,500	43,000
9	39	19,500	39,000
10	36	18,000	36,000
11	33	16,500	33,000
12	31	15,500	31,000
13	29	14,500	29,000
14	27	13,500	27,000
15	26	13,000	26,000
16	24	12,000	24,000
17	23	11,500	23,000
18	22	11,000	22,000
19	21	10,500	21,000
20	20	10,000	20,000
21	19	9,500	19,000
22	18	9,000	18,000
23	17	8,500	17,000
24	17	8,500	17,000
25	16	8,000	16,000
26	16	8,000	16,000

W/O CAP

PINS	Q' ty/Tube	Q' ty/Inner Box	Q' ty/Box
27	15	7,500	15,000
28	14	7,000	14,000
29	14	7,000	14,000
30	14	7,000	14,000
31	13	6,500	13,000
32	13	6,500	13,000
33	12	6,000	12,000
34	12	6,000	12,000
35	12	6,000	12,000
36	11	5,500	11,000
37	11	5,500	11,000
38	11	5,500	11,000
39	11	5,500	11,000
40	10	5,000	10,000
41	10	5,000	10,000
42	10	5,000	10,000
43	9	4,500	9,000
44	9	4,500	9,000
45	9	4,500	9,000
46	9	4,500	9,000
47	9	4,500	9,000
48	9	4,500	9,000
49	8	4,000	8,000
50	8	4,000	8,000

B0	2025/12/11	Standardization Drawing	BAO	OPERATION	DRAW	DATE	SCALE	FIT	PART NO.
A5	2023/02/03	Modify Flatness	XSR	x.x ±0.40	BAO	2025/12/11	UNIT	mm	SEE TABLE
A4	2020/06/24	Add DIM.&Table;Modify 02~50PIN to 02~40PIN	XSR	x.xx ±0.25	CHECK	DATE	SIZE	A4	TITLE:
A0	2012/07/05	NEW	-----	x.xxx ±0.15	TANG	2025/12/11	SHEET	4/4	1.27mm Female Header Single Row SMT H=2.0 With different post
REV	DATE	MODIFICATION DESCRIPTION	CHANGE	Angle ± 3'	APPROVE	DATE	PROJ.	Customer NO.	
				DIM TOL	Steven Zhao	2025/12/11			



Http: [www.wcon.com](http://www.wcon.com)

WCON-Dongguan Tel: +86 769 85358920 Fax: +86 769 85358915 E-mail: <a href="mailto:sales@wcon.com">sales@wcon.com</a>	WCON-Kunshan Tel: +86 512 57468408 Fax: +86 512 57468468 E-mail: <a href="mailto:salesks@wcon.com">salesks@wcon.com</a>
---	--

**HSF**

**Packaging Quantity Refers To The Following Table**

PINS	W	Q' ty/Reel	Q' ty/Inner Box	Q' ty/Box
2	16	1,600	6,400	19,200
3	16	1,600	6,400	19,200
4	16	1,600	6,400	19,200
5	24	1,600	4,800	14,400
6	24	1,600	4,800	14,400
7	24	1,600	4,800	14,400
8	24	1,600	4,800	14,400
9	24	1,600	4,800	14,400
10	32	1,600	3,200	9,600
11	32	1,600	3,200	9,600
12	32	1,600	3,200	9,600
13	32	1,600	3,200	9,600
14	32	1,600	3,200	9,600
15	44	1,600	3,200	9,600
16	44	1,600	3,200	9,600
17	44	1,600	3,200	9,600
18	44	1,600	3,200	9,600
19	44	1,600	3,200	9,600
20	44	1,600	3,200	9,600
21	44	1,600	3,200	9,600
22	44	1,600	3,200	9,600
23	44	1,600	3,200	9,600
24	56	1,600	1,600	4,800
25	56	1,600	1,600	4,800
26	56	1,600	1,600	4,800

PINS	W	Q' ty/Reel	Q' ty/Inner Box	Q' ty/Box
27	56	1,600	1,600	4,800
28	56	1,600	1,600	4,800
29	56	1,600	1,600	4,800
30	56	1,600	1,600	4,800
31	56	1,600	1,600	4,800
32	56	1,600	1,600	4,800
33	72	1,600	1,600	4,800
34	72	1,600	1,600	4,800
35	72	1,600	1,600	4,800
36	72	1,600	1,600	4,800
37	72	1,600	1,600	4,800
38	72	1,600	1,600	4,800
39	72	1,600	1,600	4,800
40	72	1,600	1,600	4,800
41	72	1,600	1,600	4,800
42	72	1,600	1,600	4,800
43	72	1,600	1,600	4,800
44	72	1,600	1,600	4,800
45	72	1,600	1,600	4,800
46	88	1,600	1,600	4,800
47	88	1,600	1,600	4,800
48	88	1,600	1,600	4,800
49	88	1,600	1,600	4,800
50	88	1,600	1,600	4,800

B0	2025/12/11	Standardization Drawing	BAO	OPERATION		DRAW	DATE	SCALE	FIT	PART NO.	
A5	2023/02/03	Modify Flatness	XSR	x.x	±0.40	BAO	2025/12/11	UNIT	mm	SEE TABLE	
A4	2020/06/24	Add DIM.&Table;Modify 02~50PIN to 02~40PIN	XSR	x.xx	±0.25	CHECK	DATE	SIZE	A4	TITLE:	
A0	2012/07/05	NEW	-----	x.xxx	±0.15	TANG	2025/12/11	SHEET	4/4	1.27mm Female Header Single Row SMT H=2.0 With different post	
REV	DATE	MODIFICATION DESCRIPTION	CHANGE	Angle	± 3'	APPROVE	DATE	PROJ.	⊕	Customer NO.	
				DIM	TOL	Steven Zhao	2025/12/11				



Http: [www.wcon.com](http://www.wcon.com)

WCON-Dongguan Tel: +86 769 85358920 Fax: +86 769 85358915 E-mail: <a href="mailto:sales@wcon.com">sales@wcon.com</a>	WCON-Kunshan Tel: +86 512 57468408 Fax: +86 512 57468468 E-mail: <a href="mailto:salesks@wcon.com">salesks@wcon.com</a>
---	--